



# Mobile Robotics Technology

**Purpose:** To evaluate each competitor's preparation for employment in the field of robotics with emphasis on the team approach to problem solving in a work environment. To recognize outstanding students for their excellence and professionalism in the emerging field of mobile robotics.

<b>On-Site/Off-Site</b>	<ul style="list-style-type: none"><li>▪ On-Site</li></ul>
<b>Contest Date</b>	<ul style="list-style-type: none"><li>▪ 4/9/2024</li></ul>
<b>Contest Location</b>	<ul style="list-style-type: none"><li>▪ Convention Center</li><li>▪ C-Hall</li></ul>
<b>Early/Normal Start Time</b>	<ul style="list-style-type: none"><li>▪ Contest Specific Start Time</li><li>▪ Registration starts at 10AM. Contest will be held from 11:30am-3:00pm.</li></ul>
<b>Contest Open/Closed</b>	<ul style="list-style-type: none"><li>▪ Open</li><li>▪ Exhibit Halls do not open to observers until 12:00pm.</li></ul>
<b>Eligibility</b>	<ul style="list-style-type: none"><li>▪ Schools may send one (1) team of two (2) competitors for every 50 paid SkillsUSA members based on local competition enrolled in a program where the scope of the contest described in the SkillsUSA Technical Content Standards reflects a major component of the program. Please refer to the National Technical Standards for more eligibility details on this contest.</li></ul>
<b>Competition Clothing (To be worn on Day 1)</b>	Business Casual: <ul style="list-style-type: none"><li>▪ Polo or other collared shirt</li><li>▪ Khakis or dress pants; no jeans</li><li>▪ Closed-toe dress shoes</li></ul>

	<ul style="list-style-type: none"> <li>▪ Note: Wearing socks or hose is no longer required. If worn, socks must be dress socks, and hose must be either black or skin-tone and seamless/nonpattern.</li> <li>▪ Note: School identifiers and contestant names must be covered.</li> </ul> <p style="text-align: center;">Or,</p> <p>Work/School Attire:</p> <ul style="list-style-type: none"> <li>▪ Field specific work clothing required for the work environment or that matches the service conditions for the contest.</li> <li>▪ This may include jeans if they are clean and professional looking and are accepted in the respective field (no holes or overly soiled pants).</li> <li>▪ Shoes or work boots with a hard sole and anti-slip properties.</li> <li>▪ Clothing should be as such that it will not get caught in moving equipment or power tools.</li> <li>▪ Professional attire worn in the classroom (school uniforms) such as a criminal justice uniform, chef attire, health scrubs, or cosmetology scrubs etc. may be worn if they meet the above requirements.</li> <li>▪ Note: School identifiers and contestant names must be covered.</li> </ul>
<p><b>Safety Equipment Required</b></p>	<ul style="list-style-type: none"> <li>▪ N/A</li> </ul>
<p><b>Awards Ceremony Attire (To be worn on Day 2)</b></p>	<p>SkillsUSA Official Attire:</p> <ul style="list-style-type: none"> <li>▪ Official SkillsUSA red blazer</li> <li>▪ Button-up, collared, white dress shirt (accompanied by a plain, solid black tie or SkillsUSA black tie), or white shirt (collarless or small-collared), with any collar not to extend into the lapel area of the blazer</li> <li>▪ Black dress slacks or black dress skirt (knee-length at minimum)</li> <li>▪ Black closed-toe dress shoes</li> <li>▪ Note: Wearing socks or hose is no longer required. If worn, socks must be black dress socks, and hose must be either black or skin-tone and seamless/nonpattern</li> </ul> <p style="text-align: center;">Or,</p>

	<p>Business Dress:</p> <ul style="list-style-type: none"> <li>▪ Blazer, sports coat, or dress</li> <li>▪ Button-up, collared, white dress shirt (accompanied by a plain, solid black tie or SkillsUSA black tie), or white shirt (collarless or small-collared), with any collar not to extend into the lapel area of the blazer</li> <li>▪ Dress slacks or dress skirt (knee-length at minimum)</li> <li>▪ Closed-toe dress shoes</li> <li>▪ Note: Wearing socks or hose is no longer required. If worn, socks must be black dress socks, and hose must be either black or skin-tone and seamless/nonpattern</li> </ul>
<b>Testing</b>	<ul style="list-style-type: none"> <li>▪ Students should be prepared to take a written knowledge test.</li> </ul>
<b>Provided by Contestant (Tool List)</b>	<p>Documentation</p> <ul style="list-style-type: none"> <li>▪ One hard copy of a 1-page personal resume</li> </ul> <p>Personal Tools</p> <ul style="list-style-type: none"> <li>▪ Teams need to bring a competition ready robot for this contest. <ul style="list-style-type: none"> <li>○ They must use the parts from <b>Appendix G</b> plus they can also include One 12" x 24" piece of polycarbonate. 1/16" thick.</li> </ul> </li> <li>▪ Engineering Notebook</li> <li>▪ Safety glasses and work gloves</li> <li>▪ Dremel (or similar) rotary tool with appropriate attachments .4</li> <li>▪ Drill and drill bits</li> <li>▪ Allen wrench set (Imperial)</li> <li>▪ Aircraft metal snippers for cutting VEX metal</li> <li>▪ A Wi-Fi enabled laptop equipped with programming software</li> <li>▪ Power strip and extension cord</li> <li>▪ Calculator (standard, scientific or graphing)</li> <li>▪ Tape measure and/or ruler</li> <li>▪ Phillips and slotted screwdrivers</li> <li>▪ Metal file</li> <li>▪ Pliers</li> <li>▪ Graph paper, pens, pencils, tape, electrical tape, markers, and scissors</li> <li>▪ Multi-meter</li> <li>▪ Replacement batteries and chargers-All 7.2V robot batteries must be made by VEX Robotics.9V and AAA can be manufactured by any vendor</li> <li>▪ Grease or graphite(non-aerosol)</li> </ul>

	<ul style="list-style-type: none"> <li>▪ VEX programming cable</li> <li>▪ Empty small parts bin or storage container</li> <li>▪ Tap set</li> <li>▪ Small toolbox (optional)</li> </ul>
<b>Contest Notes, Themes, &amp; Deadlines</b>	<ul style="list-style-type: none"> <li>▪ Note: State contest presentation time is 3-5 minutes, which differs from the National Technical standards. Contestants should be prepared to adhere to this change as deductions will occur for presentations under 3 minutes or over 5 minutes.</li> <li>▪ Interview questions, instructions, and rubrics are located in Appendix F.</li> </ul>
<b>Special Notes</b>	<ul style="list-style-type: none"> <li>▪ Starting in 2024, all State Contests will begin to add a scenario-based component.</li> <li>▪ Contact with Contest Coordinators is prohibited. Contact with Contest Coordinators outside of the SkillsUSA Ohio office may result in contestant disqualification.</li> <li>▪ All safety requirements will be heavily enforced. Violation may result in contestant disqualification.</li> <li>▪ No smart watches and/or phones are permitted during the contest and/or in contest.</li> <li>▪ No contact with anyone outside of the contest area once the contest begins.</li> <li>▪ No inappropriate communication between contestants such as verbally degrading another contest.</li> <li>▪ No cheating on any portion of the contest such as informing another contestant of the skills/test prior to competing.</li> <li>▪ Starting in 2024, Wi-Fi is provided for contests where it is required for contest success.</li> </ul>
<b>National Technical Standards</b>	<ul style="list-style-type: none"> <li>▪ Please refer to the 2023-2024 National Technical Standards for all contests. Any and all standards included may be tested in any competition.</li> <li>▪ In conjunction with National Standards, violations may result in student loss of contest.</li> </ul>
<b>Resume/Interview Requirement</b>	<ul style="list-style-type: none"> <li>▪ All SkillsUSA Ohio State Championship Contests will require a short interview component. Students should be prepared with basic job interview skills.</li> <li>▪ All contestants must have a hard copy of a one (1) page personal resume.</li> </ul>

# Mobile Robotics Technology

2023-24 Game Manual for Secondary & Post-Secondary Teams

Presented by: The Robotics Education & Competition Foundation

Adapted from: VEX Robotics Competition Over Under

# Table of Contents

Overview	3
ELIGIBILITY	3
CLOTHING REQUIREMENT	3
THE GAME	4
A Primer	4
Game Definitions	4
Game Specific Definitions	8
Scoring	11
Safety Rules	13
General Game Rules	14
VRC Over Under Specific Rules	15
Rules Specific to SkillsUSA	19
Robot Inspection	19
Design Process	19
Design Interview	20
Programming Interview	21
Safety Points	21
TEAM RANKING	21
Design Award Rubric	23
Mobile Robotics Programming Interview Questions	25
Programming Interview	30
Programming Skills Matches	31
Driving Skills Matches	32
Mobile Robotics Technology Overall Scorecard	33

## Overview

Students who participate in Mobile Robotics Technology engage in the Engineering Process and demonstrate their ability to keep and maintain an engineering notebook. Students will be judged based on their robot in design, construction, and programming, along with the quality of their notebook, and their ability to communicate their design process to the judges. Students will show the result of their preparation by performing tasks in both autonomous and driver control functions. The game that will be played is an adaptation of the VRC Over Under Robot Skills Challenge. Students can participate in both VRC and SkillsUSA using the same robot and engineering notebook. The key difference is that SkillsUSA focuses on the ability of students to create a robot that performs exceptionally at a given task, whereas VRC is a teamwork-based program that focuses on collaborating with other teams along with game strategy in a tournament structure of competition. Students in SkillsUSA should focus on designing, building and programming a robot to perform well, knowing that there are no other robots on the field that may help their robot or might get in the way.

## ELIGIBILITY

Eligibility (Team of Two)

Open to a team of two active SkillsUSA members. Each state may send one middle school, one high school, and one college/postsecondary team.

**Secondary and College/Postsecondary:** Students who are enrolled in a career and technical education engineering program or a program that integrates robotics, engineering, or pre-engineering techniques as an integral component of the instructional program.

## CLOTHING REQUIREMENT

### Class E: Competition Specific — Business Casual

- Official SkillsUSA white polo shirt
- Black dress slacks or black dress skirt (knee-length minimum)
- Black closed-toe dress shoes

**Note:** Wearing socks or hose is no longer required. If worn, socks must be black dress socks and hose must be either black or skin-tone and seamless/nonpattern.

These regulations refer to clothing items that are pictured and described at [www.skillsusastore.org](http://www.skillsusastore.org). If you have questions about clothing or other logo items, call 1-888-501-2183.

**Note:** Competitors must wear their official competition clothing to the competition orientation meeting.

# THE GAME

## A Primer

VEX Robotics Competition Over Under is played on a 12'x12' square field, set up as illustrated below and in figures throughout this game manual.

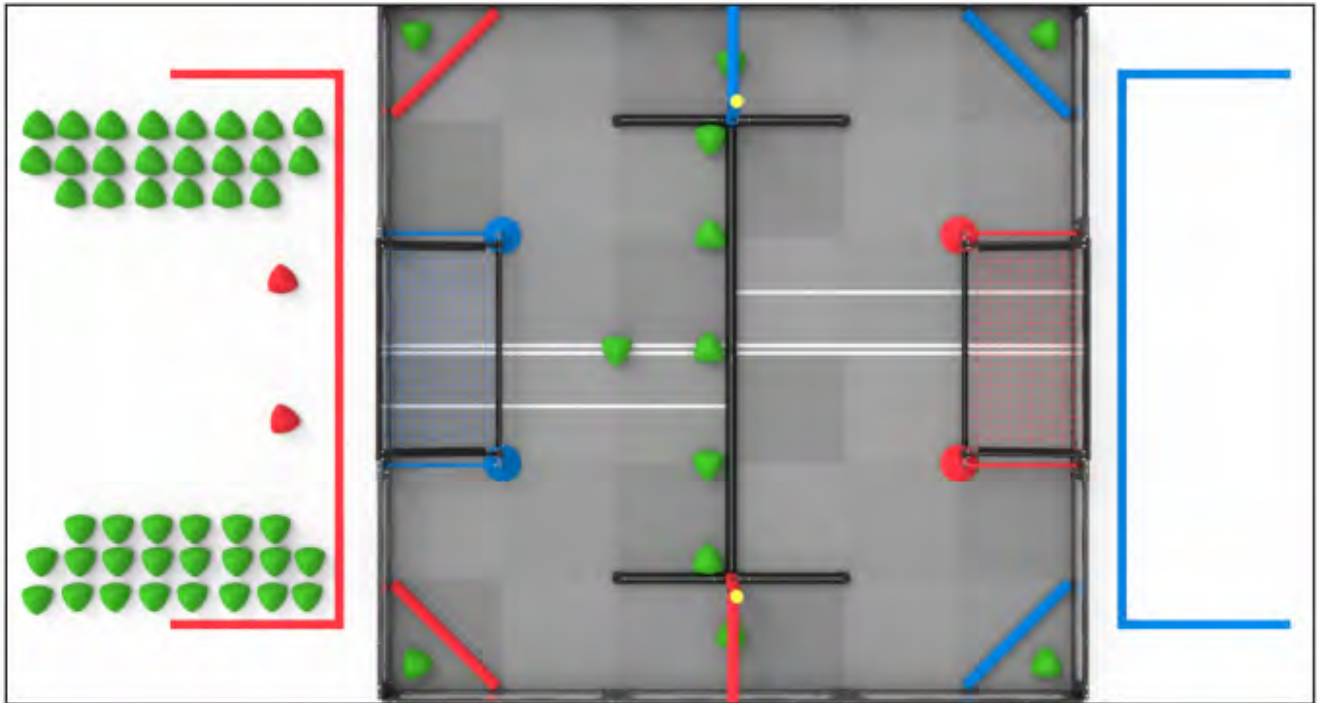

Teams compete in one-minute (1:00) Robot Skills Matches, where one (1) Robot tries to score as many points as possible for Secondary Teams and two (2) Robots driven by the same team for Post-Secondary Teams. There are two types of matches, Driving Skills and Programming Skills Matches. In Driving Skills, teams use the remote control operate the robot, and in Programming Skills, no input from the remote control is permitted. The VEX GPS code strip will be installed on the field for both types of matches.

## Game Definitions

**Adult** - Anyone who is not a Student or another defined term.

**Alliance Station** - The designated regions where the Drive Team Members must remain for the duration of the Match.



**Autonomous Coding Skills Match** – An *Autonomous Coding Skills Match* consists of a sixty-second (1:00) *Autonomous Period*. There is no *Driver Controlled Period*. Teams can elect to end their run early if they wish to record a *Skills Stop Time*.

**Disablement** - A penalty applied to a Team for a rule Violation. A Team that is Disabled is not allowed to operate their Robot for the remainder of the Match, and the Drive Team Member(s) will be asked to place their controller(s) on the ground.

**Disqualification** - A penalty applied to a Team for a rule Violation. A Team that receives a Disqualification in a Qualification Match receives zero (0) Win Points, Autonomous Win Points, Autonomous Points, and Strength of Schedule Points. When a Team is Disqualified in an Elimination Match, the entire Alliance is Disqualified and they receive a loss for the Match. At the Head Referee's discretion, repeated Violations and / or Disqualifications for a single Team may lead to its Disqualification for the entire tournament. (See <T8>)

**Drive Team Member** - A Student who stands in the Alliance Station during a Match. Adults are not allowed to be Drive Team Members. See rules <G7>, <G8>, and <G9>.

**Driving Skills Match** – A *Driving Skills Match* consists of a sixty-second (1:00) *Driver Controlled Period*. There is no *Autonomous Period*. Teams can elect to end their run early if they wish to record a *Skills Stop Time*.

**Entanglement** - A Robot status. A Robot is Entangled if it has grabbed, hooked, or attached to an opposing Robot or a Field Element. See rules <G12> and <SG3>.

**Field Element** - All elements that make up the field, including the foam field tiles, field perimeter, white tape, High Goals, Nets, Rollers, Barriers, and all supporting structures and accessories (such as Alliance Station posts, field monitors, etc.).

**Robot** - A machine that has passed inspection, designed to execute one or more tasks autonomously and / or by remote control from a Drive Team Member. Secondary Teams utilize 1 Robot and Post-Secondary Teams utilize 2 Robots.

**Robot Skills Match** – A *Driving Skills Match* or *Autonomous Coding Skills Match*.

**Student** – An eligible SkillsUSA member.

**Skills Stop Time** – The time remaining in a *Robot Skills Match* when a *Team* ends the *Match* early.

- a. If a *Team* does not end the *Match* early, they receive a default *Skills Stop Time* of 0.
- b. The moment when the *Match* ends early is defined as the moment when the *Robot* is “disabled” by the field control system. See the “*Skills Stop Time*” section for more details.
- c. If a V5 Robot Brain or Tournament Manager display is being used for field control, then the *Skills Stop Time* is the time shown on the display when the *Match* is ended early (i.e. in 1-second increments).

- d. If a VEXnet Competition Switch is being used for field control, in conjunction with a manual timer that counts down to 0 with greater accuracy than 1-second increments, then the time shown on the timer should be rounded up to the nearest second. For example, if the *Robot* is disabled and the timer shows 25.2 seconds, then the *Skills Stop Time* should be recorded as 26.

**Team** -Two Students make up a Team.

- In the context of this Game Manual, Teams include two Student roles related to Robot assembly, design, and programming. See <G2> and <G6> for more information. Adults may not fulfill any of these roles. Each student may fill one or multiple student roles.
  - **Builder** - The Student(s) on the Team who assemble(s) the Robot. Adults are permitted to teach the Builder(s) how to use concepts or tools associated with Robot construction, but may never work on the Robot without the Builder(s) present and actively participating.
  - **Designer** - The Student(s) on the Team who design(s) the Robot. Adults are permitted to teach the Designer(s) how to use concepts or tools associated with design, but may never work on the design of the Robot without the Designer(s) present and actively participating.
  - **Programmer** - The Student(s) on the Team who write(s) the computer code that is downloaded onto the Robot. Adults are permitted to teach the Programmer(s) how to use concepts or tools associated with programming, but may never work on the code that goes on the Robot without the Programmer(s) present and actively participating.

**Violation** - The act of breaking a rule in the Game Manual.

- Minor Violation - A Violation which does not result in a Disqualification.
  - Accidental, momentary, or otherwise non-Match Affecting Violations are usually Minor Violations.
  - Minor Violations usually result in a verbal warning from the Head Referee during the Match, which should serve to inform the Team that a rule is being Violated before it escalates to a Major Violation.
- Major Violation - A Violation which results in a Disqualification.
  - Unless otherwise noted in a rule, all Match Affecting Violations are Major Violations.
  - If noted in the rule, egregious or intentional Violations may also be Major Violations.
  - Multiple Minor Violations within a Match or tournament may escalate to a Major Violation, at the Head Referee's discretion.
- Match Affecting - A Violation which changes the score of a Robot Skills Match.
  - Multiple Violations within a Match can cumulatively become Match Affecting.
  - When evaluating if a Violation was Match Affecting, Head Referees will focus primarily on any Robot actions that were directly related to the Violation.
  - Determining whether a Violation was Match Affecting can only be done once the Match is complete and the scores have been calculated.

*Violation Note: In the Robot Skills Challenge, the standard definition of Match Affecting does not apply, since there is no winner and loser. When evaluating whether a rule Violation should be classified as a Major or Minor Violation in the context of this criteria, the term “score affecting” can be substituted for “Match Affecting”. A Violation is considered “score affecting” if it resulted in a net increase of that Team’s score at the end of the Match.*

To determine whether a Violation may have been Match Affecting, check whether the Team who committed the Violation won or lost the Match. If they did not win the Match, then the Violation could not have been Match Affecting, and it was very likely a Minor Violation.

See the flowchart for more information.

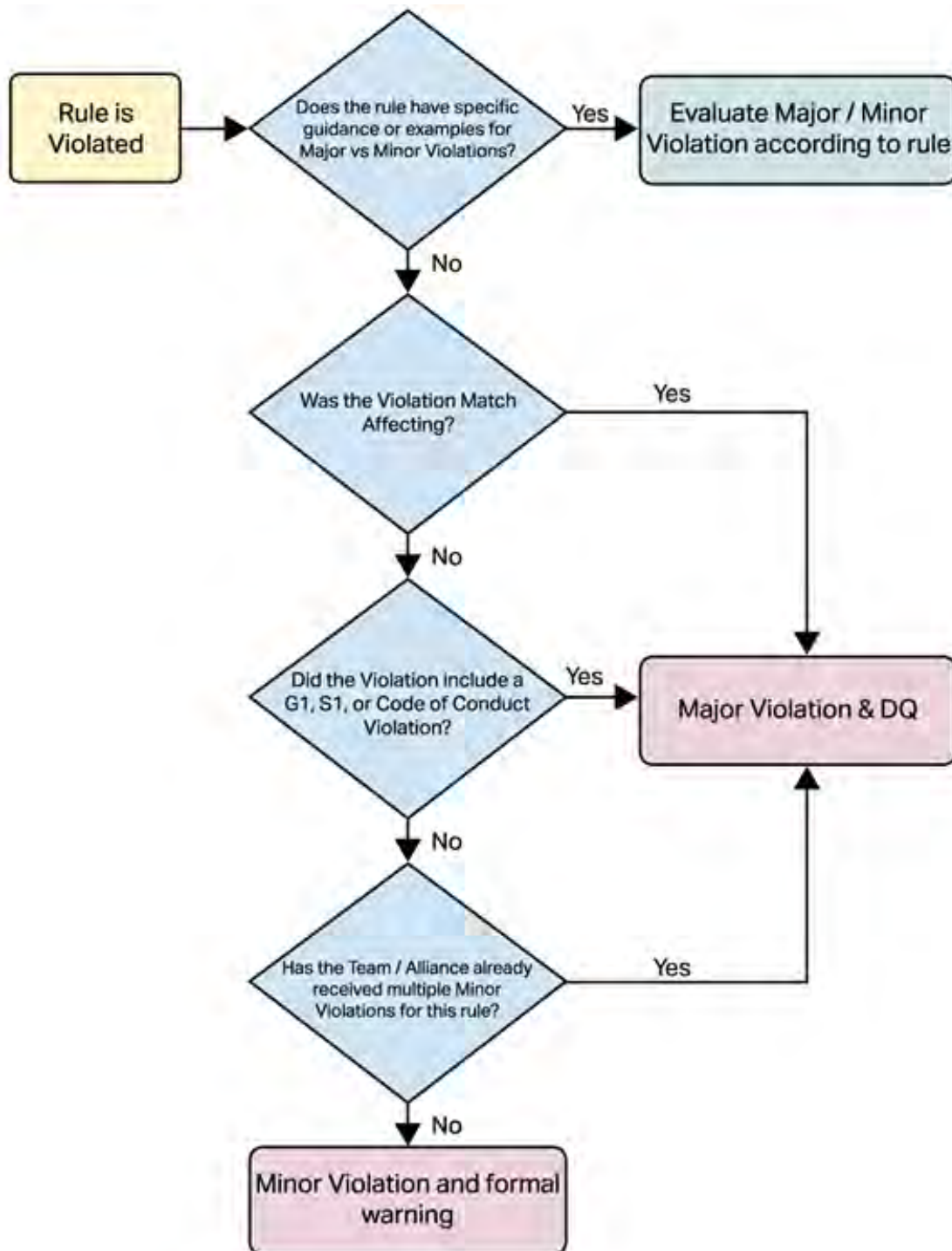

## Game Specific Definitions

**Alliance Triball** - One of four Triballs, two per Alliance, that are Alliance-colored instead of green. Alliance Triballs may be used as Preloads or Match Loads.

**Barrier** - The black structure, made up of 2" Schedule 40 PVC pipe (with a 2.375" outer diameter) PVC pipe and associated connectors/hardware, that sits in the middle of the field. For some rules, the Barrier is divided into one Long Barrier and two Short Barriers, but it is usually referred to collectively as just "the Barrier."

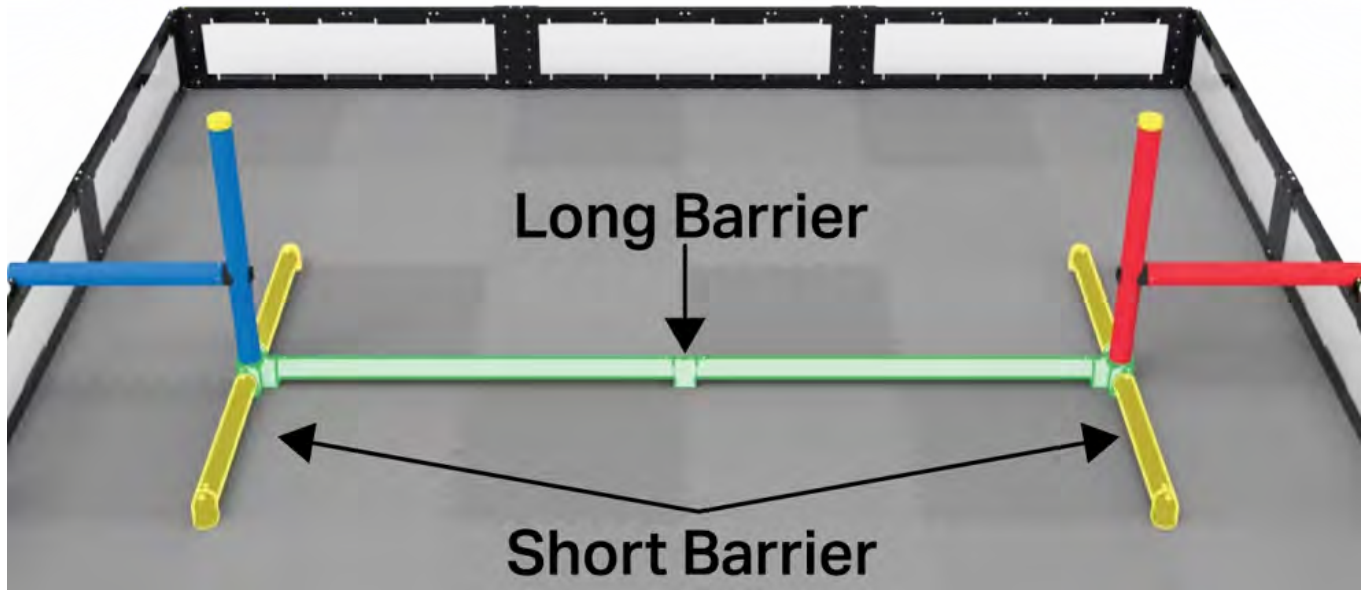

**Elevated** - A Robot status. A Robot is considered Elevated at the end of the Match if it meets the following criteria:

1. The Robot is contacting at least one of the following:
  - a. One or more of their Alliance's Elevation Bars
  - b. Any portion of the Barrier that is on their Alliance's side of the Neutral Zone (i.e., the three black PVC pipes that are attached directly to their Alliance's Elevation Bars).
  - c. An Alliance partner Robot which meets the requirements of points 1-3 in this definition
2. The Robot is not contacting any Field Elements other than those listed in point 1. This includes gray field tiles, the field perimeter, Goals, the opposing Alliance's Elevation Bar, etc.
  - a. Contact with (or Possession of) Triballs is irrelevant when determining a Robot's Elevated status.

3. The Robot is not contacting the yellow Elevation Bar Cap.

4. The Robot is not contacting an Alliance partner Robot that is not considered Elevated.

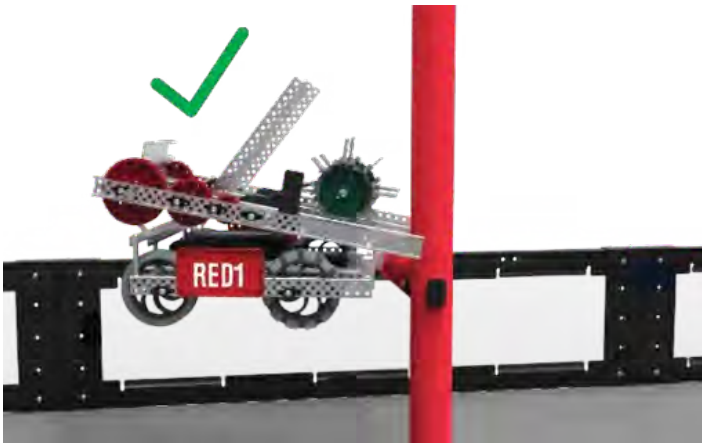

Figure 5: This Robot would be considered as Elevated, because it meets all the criteria listed above.

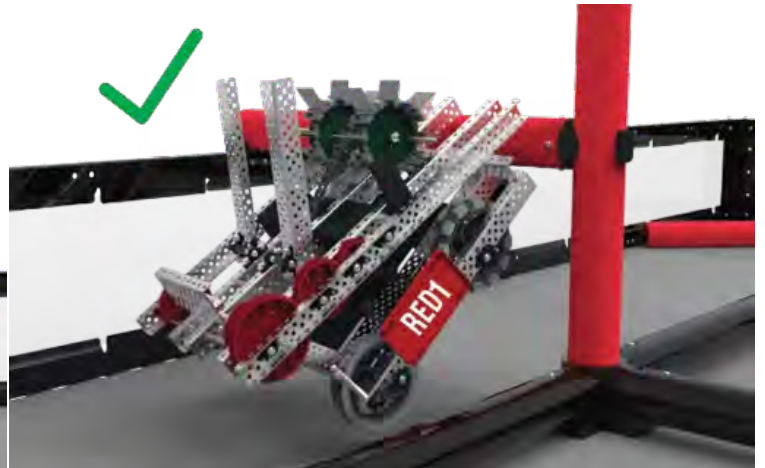

Figure 6: This Robot would be considered as Elevated because it meets all the criteria listed above.

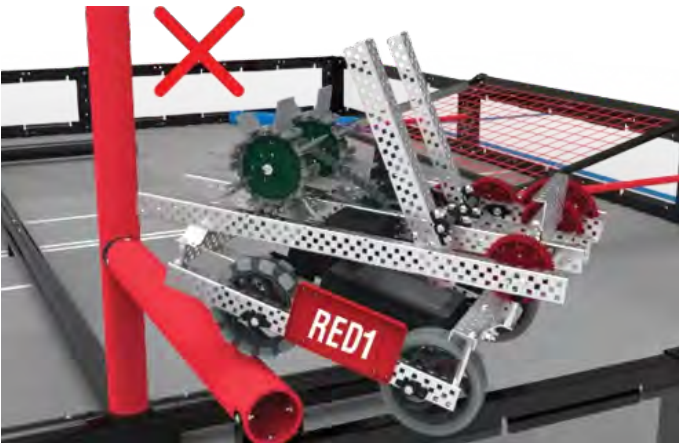

Figure 8: This Robot would not be considered as Elevated, because it is in contact with the field perimeter.

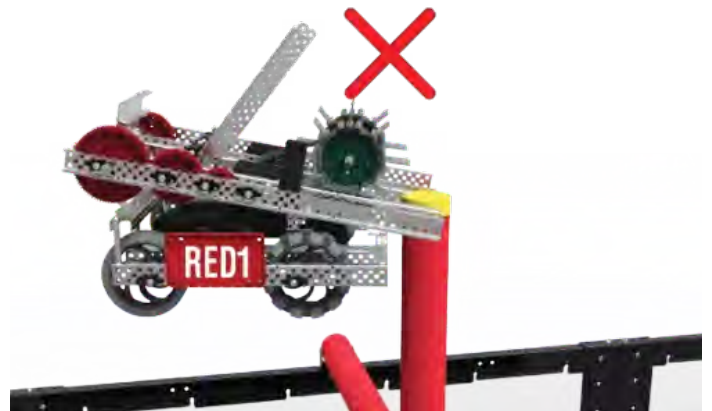

Figure 10: This Robot would not be considered as Elevated, because it is in contact with the Elevation Bar Cap.

**Elevation Bar** – The Alliance-colored PVC pipes, two red and two blue, at either end of the Barrier.

**Elevation Bar Cap** – The yellow plastic piece at the top of each set of Elevation Bars. The Elevation Bar Cap is a separate field element and is not considered part of the Elevation Bar.

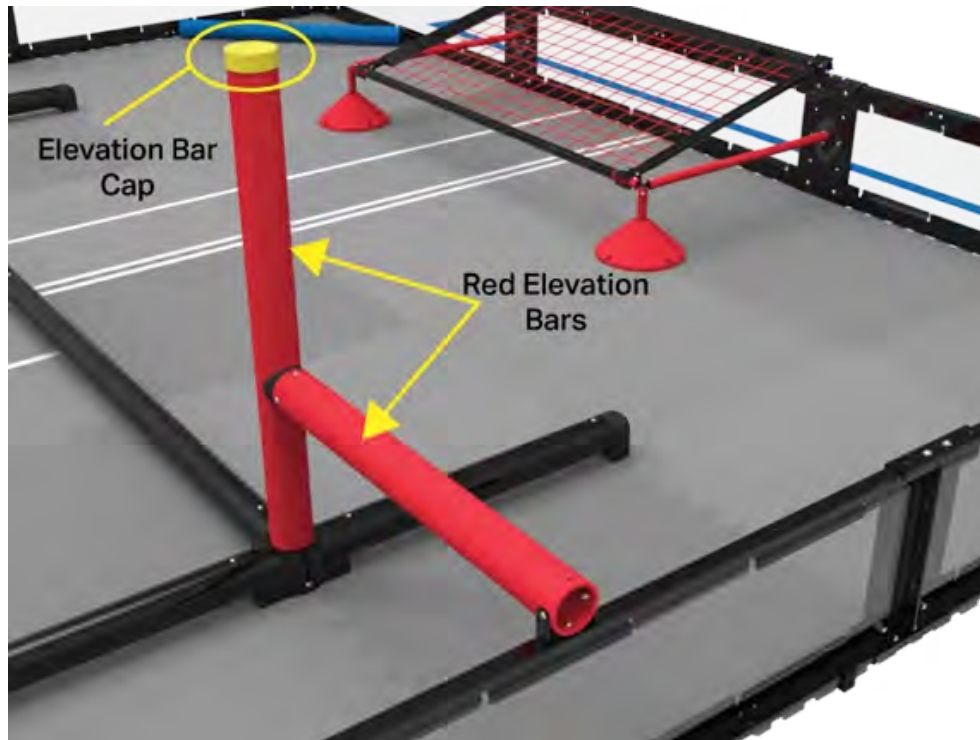

Figure 11: An Elevation Bar and Elevation Bar Cap.

**Elevation Tier** – A status that represents an Elevated Robot's height off of the field at the end of the Match. A Robot's Elevation Tier is measured by placing the Height Guide vertically next to an Elevated Robot and determining which letter-labeled segment of the Height Guide the lowest point of the Robot falls within. Each white line on the Height Guide is considered to be part of the letter-labeled segment immediately below that line. In other words, the Robot must be visibly "above the line" in order to move into the next Elevation Tier. See Figure 13.

Note: There are no additional Elevation Tiers above the Height Guide. Robots which end the Match above the Height Guide will be considered to be at the maximum, Elevation Tier J.

Note 2: Robots that are not Elevated do not receive an Elevation Tier.

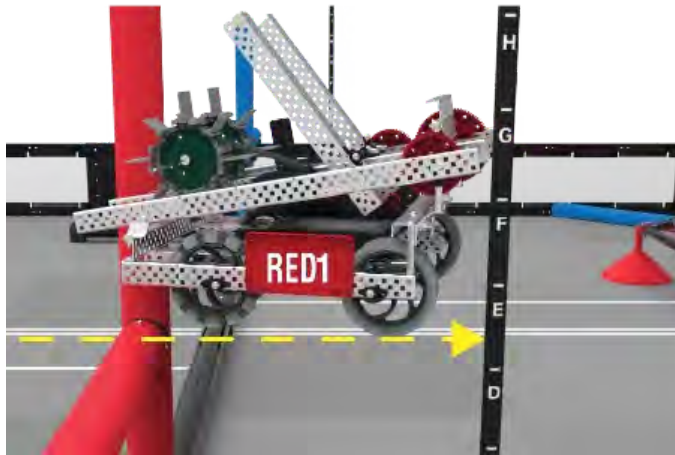

Figure 12: This Robot would be considered to be in Elevation Tier E.

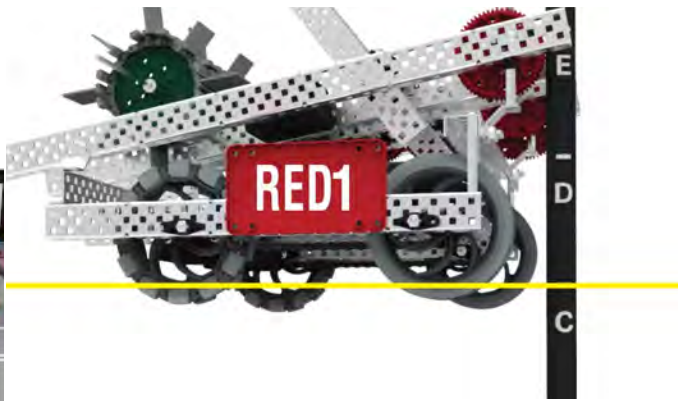

Figure 13: This Robot would be considered to be in Elevation Tier C.

**Goal** – The Alliance-colored, netted structure on either side of the field, one red and one blue, into which Triballs can be scored for points.

As a Field Element, the term “Goal” refers to the net and all supporting structures / hardware (e.g. PVC pipes and plastic bases).

For the purposes of scoring, the “Goal” refers specifically to the three-dimensional volume bounded by a vertical projection of the outermost PVC pipes onto the field and below the surface of the net.

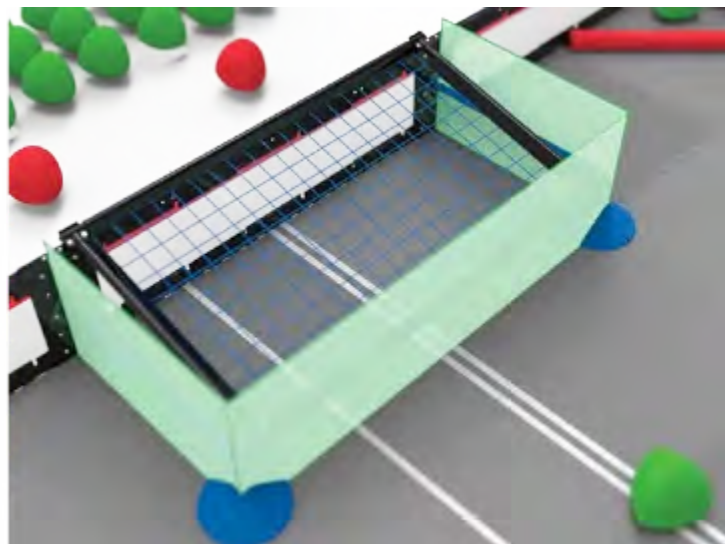

Figure 16: A Goal. The three-dimensional outer scoring boundaries are highlighted in green.

**Height Guide** – The black PVC pipe, roughly 0.84” in diameter and 36” long, which is labeled with white-printed lettered segments of approximately 3.6” each. The Height Guide is used by Referees to determine Elevation Tiers at the end of a Match. The Height Guide is a tool, not a Field Element.

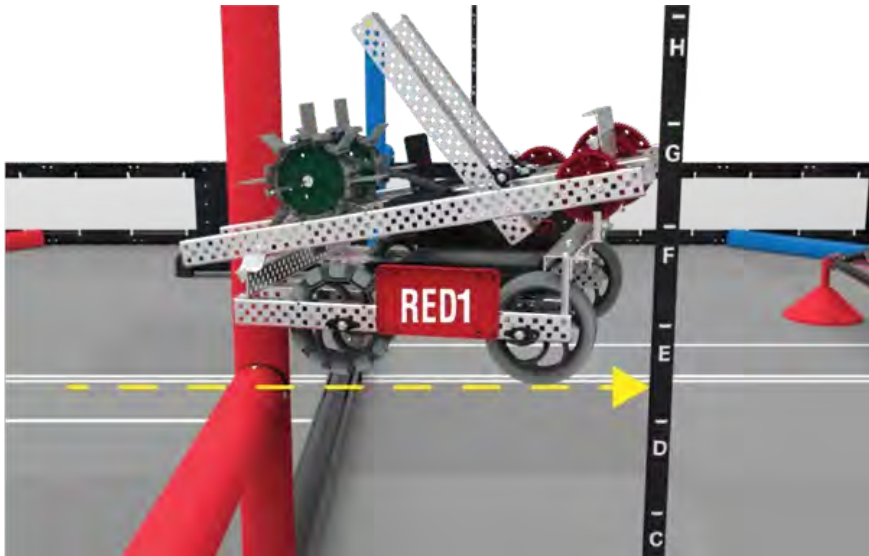

Figure 17: An example of how the Height Guide would be used to determine a Robot’s Elevation Tier.

**Match Load Bar** – The Alliance-colored structure, made up of 2” Schedule 40 PVC pipe (with a 2.375” outer diameter) and associated connectors/hardware, that connects diagonally across a corner of the Field.

**Match Load Zone** – The portion of the floor tile bordered by the red Match Load Bar and an inside corner of the Field Perimeter. Drive Team members must only load from the Red Match Load Zones

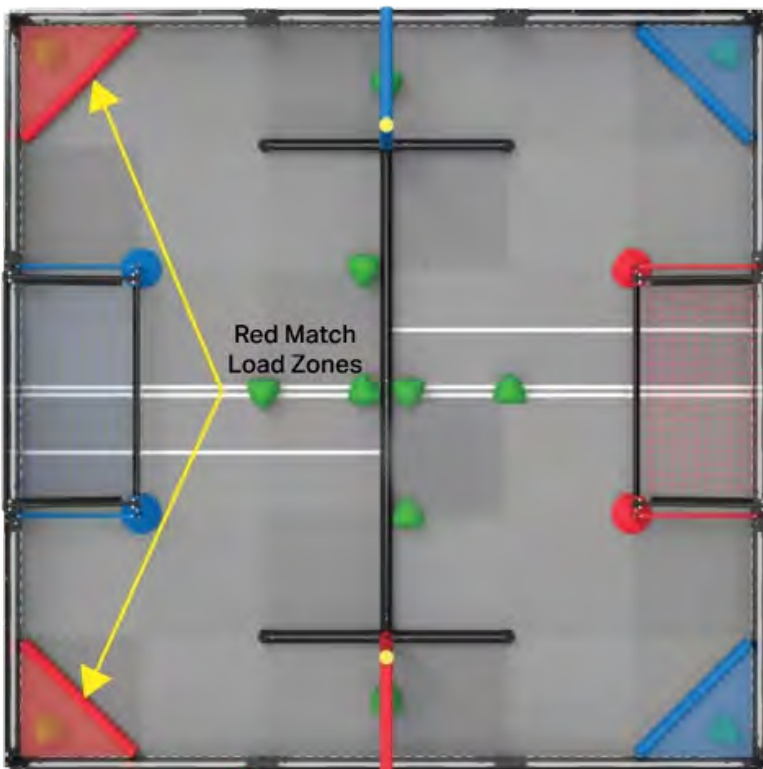
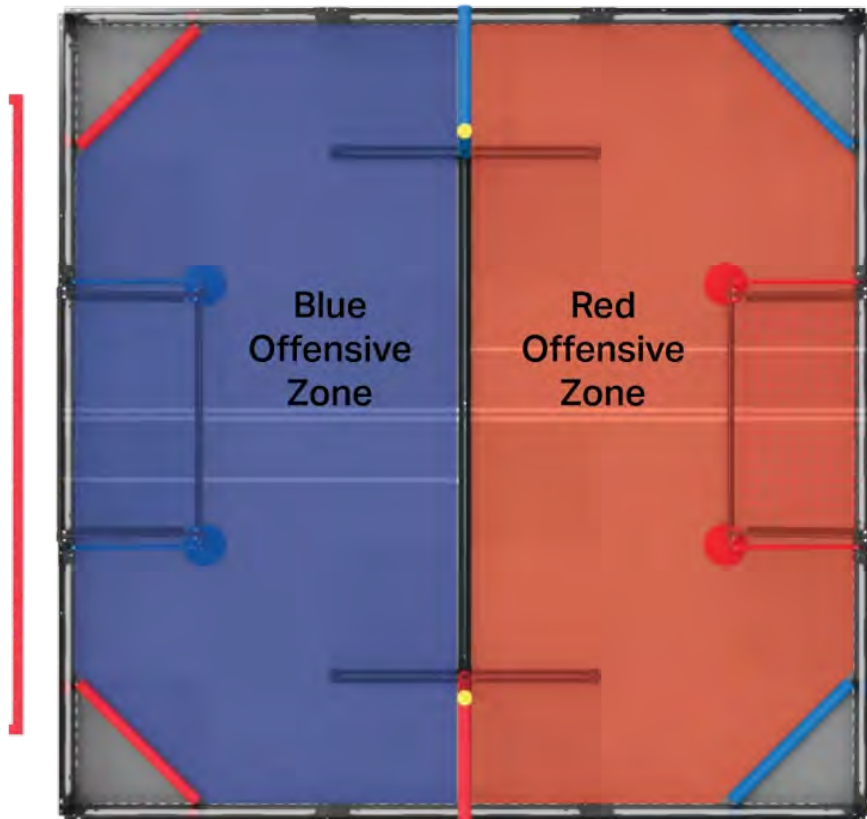

Figure 18: The four (4) Match Load Zones found on a VRC Over Under Field.



**Offensive Zone** – One of two halves of the field, divided by the Barrier. See Figure 20.

- An Alliance's Offensive Zone is on the side furthest from their Alliance Station and closest to that Alliance's colored Goal.
- Each Offensive Zone consists of the gray foam tiles on one side of the Barrier. It is not a 3-dimensional volume.
- The Long Barrier is not considered to be in either Offensive Zone.
- The Match Load Zones are not considered to be part of either Offensive Zone.



**Figure 20:** A depiction of the two Offensive Zones and their boundaries.

**Plowing** – A Robot / Triball status. A Robot is considered to be Plowing Triballs if the Robot is intentionally moving them in a preferred direction with a flat or convex face of the Robot.

**Possession** – A Robot / Triball status. A Robot is considered to be Possessing a Triball if a Robot's change in direction would result in controlled movement of the Triball. This typically requires at least one of the following to be true:

1. The Triball is fully supported by the Robot.
2. The Robot is moving the Triball in a preferred direction with a concave face of the Robot (or inside of a concave angle formed by multiple mechanisms/faces of the Robot).

**The difference between Possession and Plowing is analogous to the difference between the terms “controlling” and “moving”.**

**Preload** – An Alliance Triball, when loaded into a Robot prior to a Match. See <SG4>.

**Scored** – A Triball status. See the Scoring section.

**Starting Tile** – The gray foam tile along the edge of the field perimeter to the left of the Blue Alliance Goal. See Figure 21.

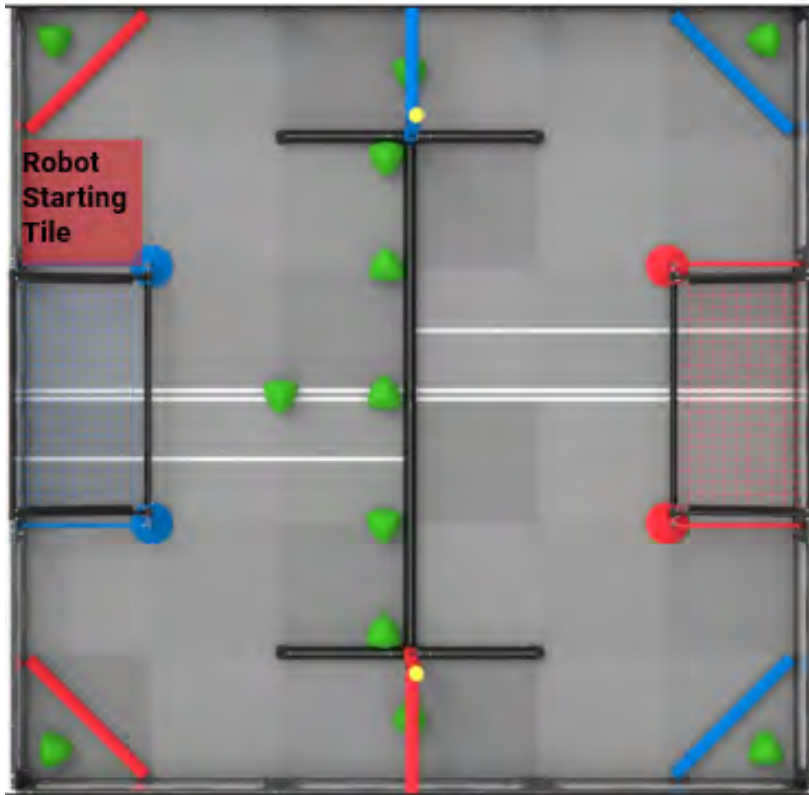

Figure 21: A depiction of the Robot Starting Tile and the boundaries.

**Triball** – A green, red, or blue plastic scoring object with a slightly rounded triangular pyramidal shape known as a Reuleaux triangle. Each Triball is approximately 6.18” tall with a weight of 103-138g.



Figure 22: The three (3) colors of Triballs used in a VRC Over Under Match.

# Scoring

Each Triball Scored in the Red Goal	<b>5 Points</b>
Each Alliance Triball Scored in a Goal	<b>5 Points</b>
Each Triball Scored in an Offensive Zone	<b>2 Points</b>
Top Tier: H or higher	<b>20 Points</b>
2nd Tier: E-G	<b>15 Points</b>
3rd Tier: B-D	<b>10 Points</b>
4th Tier:	<b>5 Points</b>

**<SC1>** All Scoring statuses are evaluated after the Match ends. Scores are calculated once all Triballs, Field Elements, and Robots on the field come to rest.

**<SC2>** A Triball is considered Scored in a Goal if it meets the following criteria:

- a. The Triball is not contacting a Robot of the same color Alliance as the Goal.
- b. At least two (2) corners of the Triball are within the Goal (i.e., are under the Net and have “broken the plane” of the outer edge of the PVC pipes that define the Goal volume).

Note: A Triball that is considered Scored in a Goal is not also considered Scored in that Goal’s Offensive Zone.

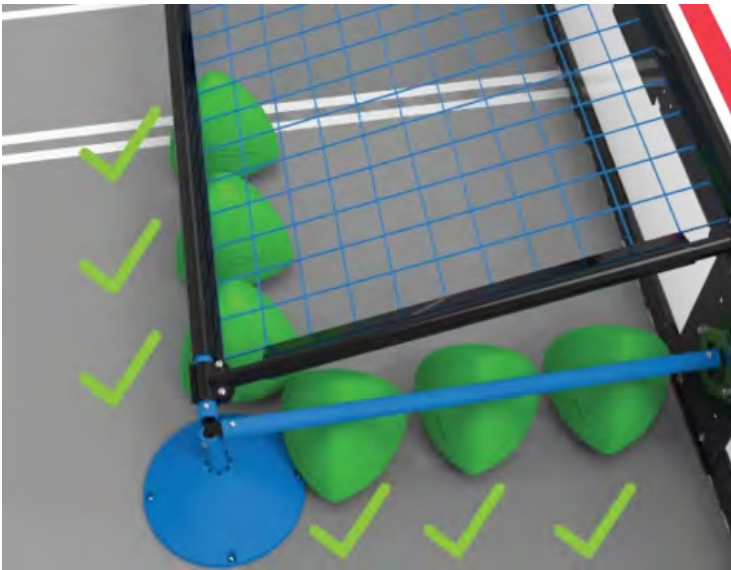

Figure 24: The green highlighted Triball considered as Scored, because two or more of the “Corners” are within the boundary of the Goal.

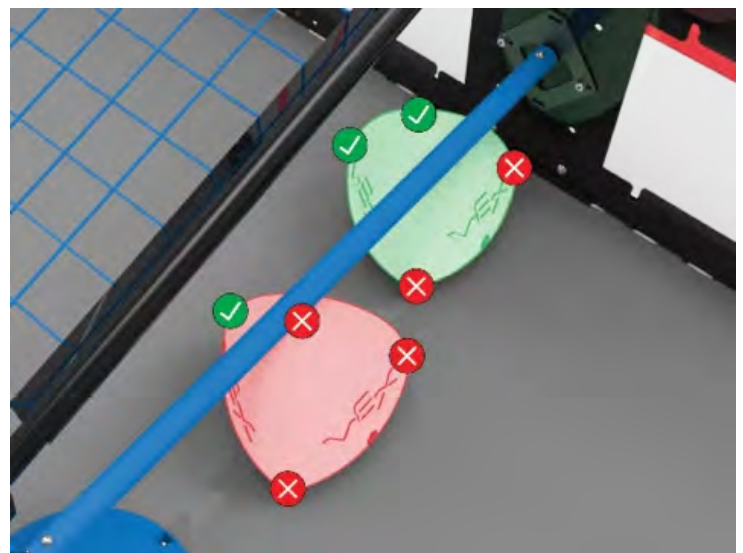

Figure 23: All of these Triballs would be considered as Scored, because 2 or more of the “Corners” are within the boundary of the Goal. The red highlighted Triball would not be considered as Scored, because only one “corner” is within the boundary.

<SC3> A Triball is considered Scored in an Offensive Zone if it meets the following criteria:

- a. The Triball is not contacting a Robot
- b. The Triball is contacting the gray foam tiles within the Red Offensive Zone and not the Blue Offensive Zone

Note: Offensive Zone scoring is based on contact with the gray foam tiles in each Offensive Zone. In the case of any close calls, referees may use a “paper test” (i.e. gently slide a piece of paper under the Triball) to determine which Offensive Zone it should be scored in. If the Triball is contacting both Offensive Zones, then it is not considered Scored in either Zone. See Figure 23.

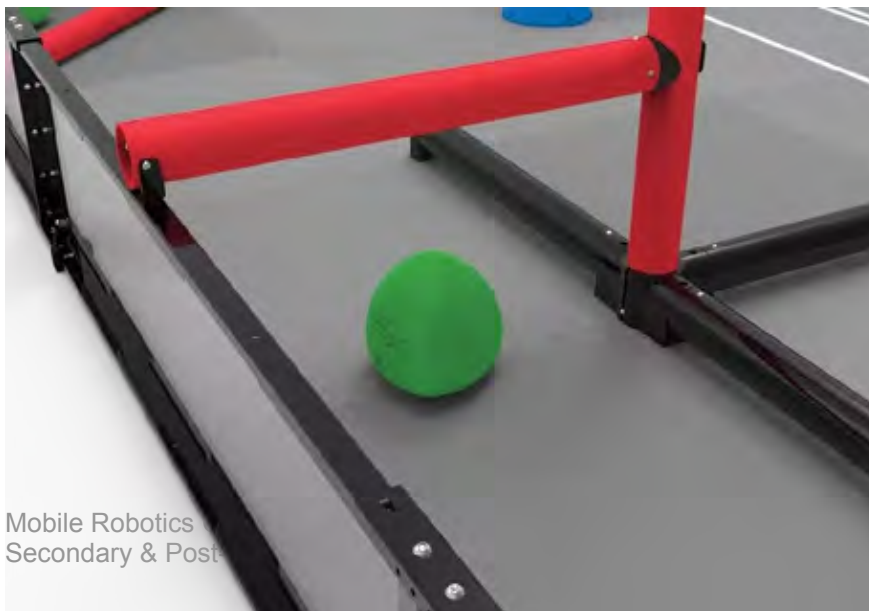

Figure 25: This Triball would not be considered as Scored in either Offensive Zone, because it is touching both zones.

**<SC4> Red Alliance Triballs** may be Scored in the Red Goal, Blue Goal, or Red Offensive Zone. For example, a red Alliance Triball that meets the definition of Scored in the blue Goal will count as 5 points.

- a. To be eligible for points, Red Alliance Triballs must not be contacting any Robots.

## Safety Rules

**<S1> Be safe out there.** If at any time the Robot operation or Team actions are deemed unsafe or have damaged a Field Element or Triball, the offending Team may receive a Disablement and/or Disqualification at the discretion of the Head Referee. The Robot will require re-inspection as described in rule <R3> before it may take the field again.

**<S2> Students must be accompanied by an Adult.** No Student may attend a VRC event without a responsible Adult supervising them. The Adult must obey all rules and be careful to not violate Student-centered policies, but must be present at the event in the case of an emergency. Violations of this rule may result in removal from the event.

**<S3> Stay inside the field.** If a Robot is completely out-of-bounds (outside the playing field), it will be Disabled for the remainder of the Match.

Note: The intent of this rule is not to penalize Robots for having mechanisms that inadvertently cross the field perimeter during normal game play. However, mechanisms which cross the field perimeter intentionally and/or repeatedly while interacting with the Match Load Zone may be considered a Violation of <S1> at the Head Referee's discretion.

**<S4> Wear safety glasses.** All Drive Team Members must wear safety glasses or glasses with side shields while in the Alliance Stations during Matches. While in the pit area, it is highly recommended that all Team members wear safety glasses.

## Specific Game Rules

**<SG1> Starting a Match.** Prior to the start of each Match, the Robot must be placed such that it is:

- a. Contacting the Robot Starting Tile. See Figure 21.
- b. Not contacting any other gray foam field tiles, including the Match Load Zones.
- c. Not contacting any Triballs other than a maximum of one (1) Preload. See rule <SG4>.
- d. Not contacting any Barriers or Elevation Bars.
  - i. Contact with the field perimeter and/or Match Load Bars is permitted, but not required.
- e. Completely stationary (i.e., no motors or other mechanisms are in motion).
- f. *Teams* may use the two (2) red *Alliance Preloads* as follows:
  - i. One *Preload* must be placed per <SG4>.

- ii. The second red *Alliance Triball* may be placed in any non-scored position in the Blue *Offensive Zone* and not touching the *Robot*, or may be used as a Match Load per <SG6> and <RSC3>.
- g. The two (2) blue *Alliance Triballs* are not used in *Robot Skills Matches*.

**Violation Notes: The Match will not begin until the conditions in this rule are met. If a Robot cannot meet these conditions in a timely manner, the Robot will be removed from the field and rules <R3d> and <T5> will apply until the situation is corrected.**

**<SG2> Horizontal expansion is limited.** Once the Match begins, Robots may expand, but no horizontal dimension may exceed 36" (914.4 mm) at any point during the Match.

- a. This limit refers to "horizontal" expansion relative to the playing field (i.e., it does not "rotate with the Robot"). For example, Robots which tip over during a Match or change orientation while Elevating are still subject to a 36" horizontal limit.
- b. There is no height limit on Robot expansion

**<SG3> Keep Triballs in the field.** Triballs that leave the field during Match play, whether intentionally or unintentionally, will be returned to the field by being placed in a Match Load Zone nearest the point at which they exited.

- a. Referees will return Triballs to the field when it is deemed safe to do so, at their discretion.
- b. This action is not considered a "Match Load", i.e., the stipulations in rule <SG6> do not apply, For example, the Triball cannot be placed directly onto a Robot.
- c. Incidental contact with other Triballs that are already in the Match Load Zone may occur, although referees will make a concerted effort not to do so.
- d. The Triball may be placed on top of other Triballs that are already in the Match Load Zone if necessary, e.g., if Triballs are already covering the entire Match Load Zone foam tile region.
- e. At their discretion, referees may also direct a nearby Drive Team Member or other volunteer to return the Triball to a specific Match Load Zone. However, this should never be done by Drive Team Members proactively without referee acknowledgment.

*Note: Triballs which come to rest on top of the red Goal may not be retrieved by a Drive Team Member or Referee during the Match. Triballs which come to rest on top of the blue Goal may be retrieved by a Drive Team Member.*

**<SG4> Robot gets two Alliance Triballs as Preloads.**

- a. Prior to the start of each Match, one Alliance Triball / Preload that is used must be placed such that it is:
  - i. Contacting one Robot of the same Alliance color as the Preload.
  - ii. Not contacting the same Robot as another Preload.
  - iii. Fully within the field perimeter.
- b. The second red Alliance Triball may be placed in any non-scored position in the Blue Offensive Zone and not touching the Robot, or may be used as a Match Load per <SG6> and <RSC3>.

If a Team does not wish to use their Preloads, or if a Robot is not present for their Match, then the Preloads may be used as Match Load Triballs in accordance with <SG6>.

Violation Notes: See <SG1>.

**<SG5> Stay away from nets on the Goals.** Becoming Entangled with the net on either Goal is considered a violation of <S1> and/or <G7>, and will result in a Disablement.

Note: Lifting the net structure in an attempt to add or remove Triballs is considered a Violation of <SG5>, and may also be considered a Violation of <G7> and/or <S1> at the Head Referee's discretion.

*Violation Notes:*

- *Momentary or incidental contact is expected and is not considered a Violation or Disablement.*
- *The Disablement associated with this rule is not considered a Major Violation. It is intended to be an avenue for the Head Referee to prevent any potential safety concerns and/or damage to the net.*
- *Intentional, strategic, or repeated Minor Violations and/or Disablements may escalate to a Major Violation at the Head Referee's discretion.*
- *Disablements last for the remainder of the match, regardless of whether the status that led to Disablement is resolved or not.*

**<SG6>** Teams may utilize the forty-four (44) Match Load Triballs within the guidelines set forth by <SG5>.

- Match Load Triballs begin the match in the red Alliance Station.
- Match Load Triballs must be introduced from the red Alliance Station per <SG6>.
- Match Load Triballs may be introduced during Autonomous Coding Skills Matches (i.e. the "Note" in rule <SG6> does not apply). Using sensors to detect legally-entered Match Load Triballs is not considered a violation of rule <G11>.

**Match Load Triballs may be safely introduced during the Match under certain conditions.** For the purpose of this rule, "introduce" refers to the moment when a Match Load Triball is no longer in contact with a human and has crossed the plane of the field perimeter.

During this action, a Drive Team Member's hand may temporarily break the plane of the field perimeter. This momentary interaction is an exception to rule <G9>. Excessive, unnecessary, or unsafe actions while introducing a Match Load may be considered a Violation of <S1> and/or <G1> at the Head Referee's discretion.

Match Load Triballs may be introduced by a Drive Team Member in one of two ways:

- By placing the Match Load gently onto a Match Load Zone. This may be done at any time during the Driver Controlled Period, provided that no other rules are Violated.
  - "Throwing," "rolling," or otherwise imparting enough energy onto a Triball such that it bounces out of the Match Load Zone is not permitted.
  - Note that the Match Load Zone refers to the foam tile itself; it is not a three-dimensional volume. There is no rules-bound limit for how many Triballs may be in the Match Load

Zone at any given time, provided that new Match Loads are placed directly onto the foam tile without violating any other rules.

- b. By placing the Match Load gently onto a Robot from the Drive Team Member's Alliance.
1. The Robot must be contacting the Match Load Zone or the Match Load Bar.
  2. Momentarily / accidentally losing contact with the Match Load Zone or Match Load Bar is permissible, provided that the Robot is still "breaking the plane" of the inside edge of the Match Load Bar. See Figure 28.
  3. Rules <S1> and <S3> still apply to this interaction; there should be no reason for a Robot to extend outside of the field perimeter during this action.

The intent of part 2b is to provide some "benefit of the doubt" to Teams for incidental Violations that may occur during rapid introduction of Match Loads. For the purposes of this rule, "momentary" refers to a duration of 2 seconds or less.

Part 2a should still be the primary driver of Robot design; part 2b is not intended to permit a design which relies solely on "breaking the plane" with no intent of the Robot ever contacting the Match Load Bar. In other words, it is still the Team's responsibility to ensure that a Head Referee can clearly determine their legality "at a glance" during a Match.

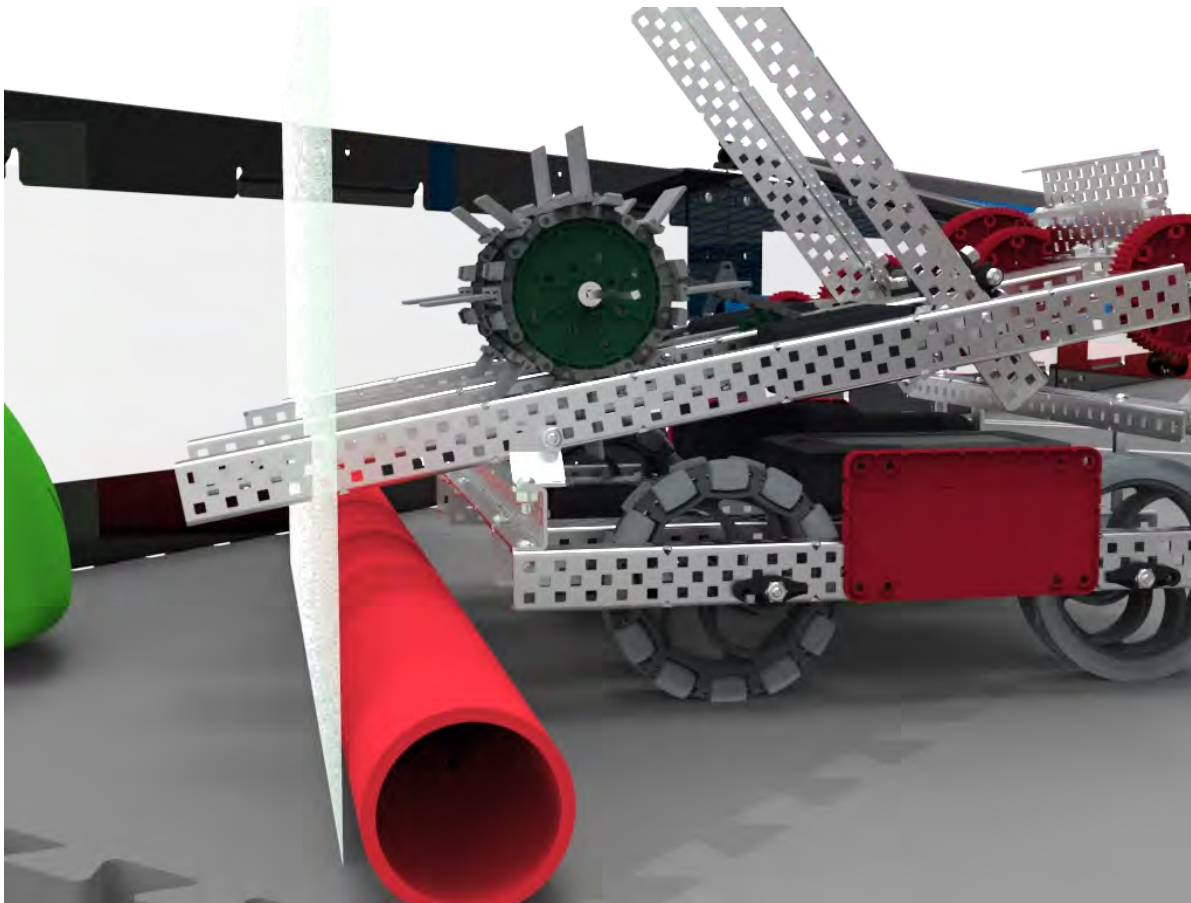



Figure 28: This Robot is not physically touching the Match Load Bar, but is still breaking the plane of the inside edge of the Match Load Bar.

**<SG7> Possession is limited to one (1) Triball.** Robots may not have greater-than-momentary Possession of more than one Triball at once. Robots in Violation of this rule must immediately stop all Robot actions except for attempting to remove the excess Triball(s). This rule applies to both intentional and accidental Possession.

**The intent of this rule is not to punish Robots for pushing Triballs that are in their way; that is, Robots are free to incidentally drive through Triballs on the field while Possessing a Triball.**

*Violation Notes:*

- *Any intentional Violation by an Alliance who wins the Match will be considered Match Affecting.*

*Examples of egregious Violations that may immediately escalate to Major Violations include, but are not limited to:*

- *Continuing to play other portions of the game (e.g., defensive maneuvers, Elevating) without attempting to remove excess Triballs for the majority of the Match*
- *“Accidentally” Possessing an egregious amount of Triballs*

Note: There are no rules prohibiting Plowing multiple Triballs. However, Robots which employ Plowing strategies should be cognizant of any accidental Possession risks while doing so, such as a Triball rolling into an intake mechanism while another one is already there.

## General Game Rules

**<G1>** Treat everyone with respect. All Teams are expected to conduct themselves in a respectful and professional manner while competing in VEX Robotics Competition events. If a Team or any of its members (Students or any Adults associated with the Team) are disrespectful or uncivil to event staff, volunteers, or fellow competitors, they may be Disqualified from a current or upcoming Match. Team conduct pertaining to may also impact a Team’s eligibility for judged awards. Repeated or extreme violations of could result in a Team being Disqualified from an entire event, depending on the severity of the situation.

**<G2>** VRC is a student-centered program. Adults may assist Students in urgent situations, but Adults may never work on or program a Robot without Students on that Team being present and actively participating. Students must be prepared to demonstrate an active understanding of their Robot’s construction and programming to judges or event staff.

**<G3>** Use common sense. When reading and applying the various rules in this document, please remember that common sense always applies in the VEX Robotics Competition.

**<G4>** The Robot must represent the skill level of the Team. Each Team must include Drive Team Members, Programmer(s), Designer(s), and Builder(s). No Student may fulfill any of these roles for more than one VEX Robotics Competition Team in a given competition season. Students may have more than one role on the Team, e.g. the Designer may also be the Builder, the Programmer and a Drive Team Member.

**<G5>** Robots begin the Match in the starting volume. At the beginning of a Match, each Robot must be smaller than a volume of 18" (457.2 mm) long by 18" (457.2 mm) wide by 18" (457.2 mm) tall. Note: Using external field influences, such as Preloads or the field perimeter wall, to maintain a Robot's starting size is only acceptable if the Robot would still satisfy the constraints of and pass inspection without these influences. Violation Notes: Any Violation of this rule will result in the Robot being removed from the field prior to the start of the Match, and rules and will apply until the situation is corrected.

**<G6>** > Keep your Robots together. Robots may not intentionally detach parts during the Match or leave mechanisms on the field. Note: Parts which become detached unintentionally and therefore a Minor Violation are no longer considered "part of a Robot," and should be ignored for the purposes of any rules which involve Robot contact or location (e.g., Scoring, Double-Zone, etc.) or Robot size. Violation Notes: Major Violations of this rule should be rare, as Robots should never be designed to intentionally violate it. Minor Violations are usually due to Robots being damaged during gameplay, such as a wheel falling of

**<G7>** > Don't clamp your Robot to the field. Robots may not intentionally grasp, grapple, or attach to any Field Elements other than the Elevation Bars. Strategies with mechanisms that react against multiple sides of a Field Element in an effort to latch or clamp onto said Field Element are prohibited. The intent of this rule is to prevent Teams from both unintentionally damaging the field and/or from anchoring themselves to the field in locations other than the Elevation Bars. Violation Notes: Major Violations of this rule should be rare, as Robots should never be designed to intentionally violate it.

**<G8>** Only Drivers, and only in the Alliance Station. During a Match, each Team may have up to three (3) Drive Team Members in their Alliance Station, and all Drive Team Members must remain in their Alliance Station for the duration of the Match. Drive Team Members are prohibited from any of the following actions during a Match: a. Bringing/using any sort of communication devices into the Alliance Station. Devices with communication features turned off (e.g., a phone in airplane mode) are allowed. b. Standing on any sort of object during a Match, regardless of whether the field is on the floor or elevated. c. Bringing/using additional materials to simplify the game challenge during a Match

**<G9>** Hands out of the field. Drive Team Members are prohibited from making intentional contact with any Discs, Field Elements, or Robots during a Match

**<G10>** > Controllers must stay connected to the field. Prior to the beginning of each Match, Drive Team Members must plug their V5 Controller into the field's control system. This cable must remain plugged in for the duration of the Match, and may not be removed until the "all-clear" has been given for Drive Team Members to retrieve their Robots. See for more information regarding field control system options. Violation Notes: The intent of this rule is to ensure that Robots abide by commands sent by the tournament software. Temporarily removing the cable to assist with mid-Match troubleshooting, with an Event Partner or other event technical staff present and assisting, would not be considered a Violation.

**<G11>** Autonomous means "no humans." During the Autonomous Coding Skills Match, Drive Team Members are not permitted to interact with the Robots in any way, directly or indirectly. This could include, but is not limited to: • Activating any controls on their V5 Controllers. Unplugging or otherwise manually interfering with the field connection in any way

Manually triggering sensors (including the Vision Sensor) in any way, even without touching them

## Rules Specific to SkillsUSA

**<SkillsUSA1>** This manual will be updated for NLSC. Rules in this manual are subject to change for NLSC and will be announced when teams arrive at the Championship for the Orientation Meeting. Teams should be prepared for the following changes which may or may not occur. No other rules will be changed.

- a. The starting position of all Game Objects.
- b. The starting position of the Robot.
- c. Which goals count for points.
- d. Values for scoring.

**<SkillsUSA2>** No Power Tools. Teams may not use power tools in the competition or pit areas. Hand tools are the only acceptable means of cutting and bending materials.

## Robot Inspection

All Robot Equipment rules are identical to the VRC Over Under Game Manual and Referenced Appendix G

- Secondary Teams utilize one 18x18x18 inch maximum size robot.
- Post-Secondary Teams utilize two 18x18x18 inch maximum size robots.

In addition to these rules, SkillsUSA teams may have 3D printed parts.

- An unlimited amount of plastic 3D printed parts may be used on the Robot using PLA, PETG and/or ABS. These parts must be documented in the Engineering Notebook and explained why they are chosen including how they were printed.

Note: Using a 3D printer to make molds for casting or injection molding is not legal and not within the spirit of this rule.

## Design Process

Judges must use the Design Rubric to evaluate the teams' design process. A record of all teams submitting notebooks shall be kept by the Judge Advisor. Notebooks shall be collected during the orientation meeting and brought to the Judges' room for evaluation. The Rubric comes in two (2) pages. The first page is for the Engineering Notebook, and the second page is for the Design Interview.

The Engineering Notebook is a way for teams to document how the VEX Robotics Competition experience has helped them to better understand the engineering design process while also practicing a variety of critical life skills including project management, time management, brainstorming, and teamwork. Bound notebooks are preferred by Judges and are given a 3-point bonus on the Design Rubric.

Each notebook is created through a concerted effort by a team to document their design decisions.

Engineering is an iterative process whereby students recognize and define a problem, brainstorm and work through various stages of the design process, test their designs, continue to improve their designs, and continue the process until a solution has been identified. During this process, students will come across obstacles, encounter instances of success and failure, and learn many lessons. It is this iterative process that students should document in their Engineering Notebook.

The Engineering Notebook is an opportunity to document everything a team does throughout the design process. Students should include a number of items in their Engineering Notebook including:

- A table of contents
- Team meeting notes as they relate to the design process
- Design concepts, sketches and pictures
- Notes from competitions regarding observations that should be considered in the next iteration of their design
- Programming improvements or significant modifications
- CAD drawings of their Robot and/or specific elements of their Robot.
- Team members' observations and thoughts on their design
- Team organization practices as they relate to their design process
- Other documentation that a team finds useful as related to their robot's design

The team should also document their project management practices including their use of personnel, financial, and time resources.

A bound quad-ruled notebook is the preferred format. The team number should be on the cover. The notebook should never be edited. Pages should never be removed from the notebook even if they contain errors. The notebook should be written in ink with errors crossed out using a single line. Pages should be numbered, and entries should be dated in chronological order with each page signed or initialed by the students. Additional materials such as examples of computer code or CAD drawings should be glued or taped into the notebook.

The question of what is a 'bound' Engineering Notebook often arises. To be considered bound, a notebook must have been bound prior to any entries being made in it.

Judges will not accept electronic notebooks on laptops, thumb drives, or cloud-based servers.

## Design Interview

All teams will be interviewed by Judges who will ask them questions about their robot and design process. Teams should bring their robot with them to the interview. Judges will fill out page 2 of the Design Rubric and give teams a score based on the responses of the team members. Teams are not to prepare a slide presentation such as Power Point for this interview and should be prepared to talk about their robot without any written notes such as cards or written outlines.

Appendix A contains the Design Award Rubric and Design Interview Rubric.

## Programming Interview

All teams will be interviewed by Judges who will ask questions about the coding and programming process. Teams should bring their robot, laptop and programming cable with them to the interview. Judges will use the following interview process rubric to determine the knowledge of the programmer and quality of the written code.

Appendix B contains the Programming Interview questions.

Appendix C contains the Programming Interview Scorecard.

## Safety Points

All teams are expected to be safe in the competition area. Students will start with 65-points in Safety and will be deducted 10-points for every instance of a safety violation. The minimum score is zero.

Students will be notified immediately upon each instance of a safety violation. Examples of Safety violations are as follows.

- General horseplay (running, throwing objects, pushing others)
- Not wearing shoes (except when walking on foam tiles)
- Not wearing safety glasses while working on Robot
- Not wearing safety glasses while standing in the Alliance Station
- Using teeth as a tool (other than eating)
- Leaving equipment in aisles (creating trip hazards)

## TEAM RANKING

Teams will be given a total score based on the Professional Development Test, Engineering Notebook (Page 1 of the Design Rubric), CAD drawings, the Design Interview (Page 2 of the Design Rubric), the Programming Interview, the team's highest Programming Skills Score, the team's highest Driving Skills Score, and the Team's Safety Score. Teams are ranked by the sum of their weighted scores in these categories.

All teams will be given the same number of Robot Skills Matches to be determined by the Competition Organizer. At SkillsUSA NLSC, each team will get three (3) chances for Programming Skills and three (3) chances for Driving Skills. Only the highest Programming Skills score and the highest Driving Skills score will be used to determine rankings.

In the case of ties, the tie will be broken by looking at the following in order.

1. Engineering Notebook Score
2. Team's highest Programming Skills Score
3. Team's highest Driving Skills Score

Appendix F contains the Mobile Robotics Technology Overall Scorecard.

# MOBILE ROBOTICS TECHNOLOGY

## APPENDIX F

## Engineering Notebook Rubric

Team # \_\_\_\_\_

Grade Level  ES |  MS |  HS |  VEX U

Judge Name: \_\_\_\_\_

CRITERIA	PROFICIENCY LEVEL			POINTS
ENGINEERING DESIGN PROCESS	EXPERT (4-5 POINTS)	PROFICIENT (2-3 POINTS)	EMERGING (0-1 POINTS)	
<b>IDENTIFY THE PROBLEM</b>	<u>Identifies</u> the game and robot design challenges <u>in detail at the start of each design process cycle</u> with words and pictures. States the goals for accomplishing the challenge.	Identifies the challenge at the start of each design cycle. <u>Lacking details in words, pictures, or goals.</u>	<u>Does not identify the challenge</u> at the start of each design cycle.	
<b>BRAINSTORM, DIAGRAM, OR PROTOTYPE SOLUTIONS</b>	<u>Lists three or more possible solutions</u> to the challenge with labeled diagrams. Citations provided for ideas that came from outside sources such as online videos or other teams.	<u>Lists one or two possible solutions</u> to the challenge. Citations provided for ideas that came from outside sources.	<u>Does not list any solutions</u> to the challenge.	
<b>SELECT BEST SOLUTION AND PLAN</b>	Explains why the solution was selected through testing and/or a decision matrix. <u>Fully describes the plan</u> to implement the solution.	Explains why the solution was selected. <u>Mentions the plan.</u>	<u>Does not explain any plan</u> or why the solution or plan was selected.	
<b>BUILD AND PROGRAM THE SOLUTION</b>	Records the steps to build and program the solution. Includes <u>enough detail that the reader can follow the logic</u> used by the team to develop their robot design, as well as recreate the robot design from the documentation.	Records the key steps to build and program the solution. <u>Lacks sufficient detail for the reader to follow the design process.</u>	<u>Does not record the key steps</u> to build and program the solution.	
<b>TEST SOLUTION</b>	<u>Records all the steps</u> to test the solution, including test results.	<u>Records the key steps</u> to test the solution.	<u>Does not record steps</u> to test the solution.	
<b>REPEAT DESIGN PROCESS</b>	Shows that the <u>design process is repeated multiple times</u> to improve performance on a design goal, or robot/game performance.	<u>Design process is not often repeated</u> for design goals or robot/game performance.	<u>Does not show that the design process is repeated.</u>	
<b>INNOVATION/ ORIGINALITY</b>	Team shows evidence of independent inquiry <u>from the beginning stages</u> of their design process	Team shows evidence of independent inquiry for <u>some elements</u> of their design process	Team <u>shows little to no evidence</u> of independent inquiry in their design process	
<b>USEABILITY AND COMPLETENESS</b>	<u>Records the entire design and development process</u> in such clarity and detail that the reader could recreate the project's history.	Records the design and development process completely but <u>lacks sufficient detail</u>	<u>Lacks sufficient detail</u> to understand the design process.	
<b>RECORD OF TEAM AND PROJECT MANAGEMENT</b>	Provides a <u>complete record of team and project assignments</u> ; team meeting notes including goals, decisions, and building/programming accomplishments; Design cycles are easily identified. Resource constraints including time and materials are noted throughout.	Records <u>most of the information listed</u> at the left. Level of detail is inconsistent, or some aspects are missing.	<u>Does not record most of the information</u> listed at the left. Not organized.	
<b>NOTEBOOK FORMAT</b>	Five (5) points if the notebook has evidence that documentation was done in sequence with the design process. This can take the form of dated entries with the names of contributing students included and an overall system of organization. For example, numbered pages and a table of contents with entries organized for future reference.		ZERO POINTS (DOES NOT MEET CRITERIA)  If awarding zero points, please include details in the "NOTES" area below.	
<b>NOTES:</b> 				TOTAL POINTS

**CAD Drawings**  
**(Keep separate from Engineering Notebook Score)**

**1 point** = Made an attempt to have a CAD drawing, but it is not accurate

**2-3 points** = Have basic elements of CAD drawings

**4-5 points** = Have detailed CAD drawings for entire Robot including some early iterations of design

**CAD Score** \_\_\_\_\_

*All Judging materials are strictly confidential. They are not shared beyond the Judges/Judge Advisor and shall be destroyed at the end of the event.*

## Team Interview Rubric

Team # \_\_\_\_\_ Grade Level  ES |  MS |  HS |  VEX U Judge Name: \_\_\_\_\_

**Directions:** Determine a point value that best characterizes the content of the Team Interview for that criterion. Write that value in the column to the right.

CRITERIA	PROFICIENCY LEVEL			POINTS
	EXPERT <small>(4-5 POINTS)</small>	PROFICIENT <small>(2-3 POINTS)</small>	EMERGING <small>(0-1 POINTS)</small>	
<b>ENGINEERING DESIGN PROCESS</b> <small>All Awards</small>	Team shows evidence of independent inquiry <u>from the beginning stages</u> of their design process. This includes brainstorming, testing, and exploring alternative solutions	Team shows evidence of independent inquiry for <u>some elements</u> of their design process	Team <u>shows little to no evidence</u> of independent inquiry in their design process	
<b>GAME STRATEGIES</b> <small>Design, Innovate, Create</small>	Team can <u>fully explain</u> their <u>entire</u> game strategy including game analysis	Team can explain their current strategy with <u>limited evidence of game analysis</u>	Team <u>did not explain</u> game strategy/strategy is not student-directed	
<b>ROBOT DESIGN</b> <small>Design, Innovate, Create, Amaze</small>	Team can <u>fully explain</u> the evolution of their robot design to the current design	Team can provide a <u>limited description</u> of why the current robot design was chosen, but shows limited evolution	Team <u>did not explain</u> robot design /design is not student-directed	
<b>ROBOT BUILD</b> <small>Build, Create, Amaze</small>	Team can <u>fully explain</u> their robot construction. Ownership of the robot build is evident	Team can describe why the current robot design was chosen, but with <u>limited explanation</u>	Team <u>did not explain</u> robot build/build is not student-directed	
<b>ROBOT PROGRAMMING</b> <small>Think, Amaze</small>	Team can <u>fully explain</u> the evolution of their programming	Team can describe how the current programs work, but with <u>limited evolution</u>	Team <u>did not explain</u> programming or programming is not student-directed	
<b>TEAM AND PROJECT MANAGEMENT</b> <small>All Awards</small>	Team can explain how team <u>progress was tracked against an overall project timeline</u> . Team can explain management of material and personnel resources	Team can explain how team <u>progress was monitored, and some degree of management of material and personnel resources</u>	Team cannot explain how <u>team progress was monitored</u> or how resources were managed.	
<b>TEAMWORK, COMMUNICATION, PROFESSIONALISM</b> <small>All Awards</small>	<u>Most or all team members contribute to explanations</u> of the design process, game strategy, and other work done by the team.	<u>Some team members contribute to explanations</u> of the design process, game strategy, and other work done by the team.	<u>Few team members contribute to explanations</u> of the design process, game strategy, and other work done by the team.	
<b>RESPECT, COURTESY, POSITIVITY</b> <small>All Awards</small>	Team consistently <u>interacts respectfully, courteously, and positively</u> in their interview	Team interactions show <u>signs of respect and courtesy, but there is room for improvement</u>	Team interactions <u>lack respectful and courteous behavior</u>	
<b>SPECIAL ATTRIBUTES AND OVERALL IMPRESSIONS</b> <small>Judges: Inspire</small>	Does the team have any special attributes, accomplishments, or exemplary effort in overcoming challenges at this event? Did anything stand out about this team in their interview? Please describe: 			TOTAL POINTS
NOTES: 				

**Professional Dress**  
**(Add this to the Design Interview Score)**

As the students walk into the interview, check to see if their shirts are fully tucked in.

Add 5 points if BOTH students have their shirts fully tucked in.

**Professional Dress Score** \_\_\_\_\_  
**(5 or 0)**

All judging materials are strictly confidential. They are not shared beyond the Judges/Judge Advisor and shall be destroyed at the end of the event.



# Mobile Robotics Programming Interview Questions

This interview is comprised of 3 sections. For each section please read all instructions and questions before assessing the team.

Please pay attention to the students' Professional Dress as they walk into the interview. There is a point value evaluation on the Programming Interview Scorecard for this category.

## Section 1: General Programming Information (Maximum 15 pts)

For this section you will be asking the team general information about their program. This section will make sure teams have come prepared for their interview.

### 1. Did the team bring a laptop with their code?

No (0 pts)		Yes (5 pts)	
------------	--	-------------	--

### 2. Did the team bring their robot?

No (0 pts)		Yes (5 pts)	
------------	--	-------------	--

### 3. Ask the team, what programming software are they using. Does it match the code that was brought to the interview?

No (0 pts)		Yes (5 pts)	
------------	--	-------------	--

---

## Section 2: Program Design and Fluency (Maximum 60 pts)

In this section you will ask the team to walk you through their code. Ask the team to start at the very beginning and explain the program until the robot stops. Read all questions beforehand because you will need to assess the program after the walk through is complete. The following questions are for the judge and should not be asked to the team.

### 4. Did the program include comments?

1 pt	2 pt	5 pt	9 pt	10 pt
Program did not contain comments.	Program contained comments but lacked in depth. The comments were only useful for the programmer.			Program contained in depth comments for their entire code base. Comments were articulate and meaningful.

### 5. Did the program use variables instead of hard coding numbers? (e.g., when they set the speed of the motor, is it a number or a variable)?

1 pt	2 pt	5 pt	9 pt	10 pt
Program did not include any variables.	Program contained a mix of variables and hard coded values. Variable may not be organized.			The program used variables for all or most opportunities. Variables were organized and named in a meaningful way.

### 6. Did the program contain advanced programming structures like loops and if else statements?

1 pt	2 pt	5 pt	9 pt	10 pt
Program did not contain any loops or if else statements.	The program only had a few loops or if/else structure. Some parts of the code were reused in loops but others were programmed linearly.			The program contained many loops and if/else structures.

**7. Did the program contain functions that were used throughout their code?**

<b>1 pt</b>	<b>2 pt</b>	<b>5 pt</b>	<b>9 pt</b>	<b>10 pt</b>
Program did not contain any functions.	The program used some functions but missed opportunities to make a function.			The program had multiple functions and was used to reuse code wherever possible in their program.

**8. Is the code formatted in an organized manner?**

<b>1 pt</b>	<b>2 pt</b>	<b>5 pt</b>	<b>9 pt</b>	<b>10 pt</b>
Program did not follow any kind of format. Code was not properly indented or spaced in a neat fashion.	Most or some of the code was formatted. There are areas where code could have been formatted a little better.			The entire code base is formatted and spaced.

**9. How did the team conduct the walkthrough of their code?**

<b>1 pt</b>	<b>2 pt</b>	<b>5 pt</b>	<b>9 pt</b>	<b>10 pt</b>
The team showed zero or minimal knowledge of their program. They were not able to articulate what their program does or where it starts.	Team was able to walk you through the program. Students read the comments verbatim and were not able to explain more than what was already written in the program. The team was unsure about how some of the code worked in some sections.			The team was able to explain all parts of their program. The team used proper terminology when talking about their program. The team was able to explain their code without having to read the comments verbatim.

---

**Section 3: Smart Programming (Maximum 15 pts)**

In this section you will be asking the team specific questions about their program. The judge will assess the team on how well they answer each question.

**10. Ask the team how many sensors are on their robot that they programmed.**

1 pt	2 pt	3 pt	4 pt	5 pt
Team uses one or less sensors on their robot.	The team uses a moderate amount of sensors (2 - 3).			Team used a large amount of sensors (4+).

**11. Find a sensor on the team's robot or one they mentioned in the question above. An example could be an Encoder in the Smart Motor. Ask the team to show you where in their code that they use this sensor. Is the team able to explain and show you how they used the sensor?**

1 pt	2 pt	5 pt	9 pt	10 pt
Team did not use any sensors or could not find how they used the sensor in their code.	The team struggled to find where they used the sensor in their code, and/or was only able to explain how they used the sensor by reading comments in that section. The team did not fully understand what data was being collected by the sensor and how it was used by the program.			Teams were able to quickly find the sensor in their program. They were able to explain in great detail how the program uses the data from the sensor.

**SCORECARD**

Programming Interview

**Team Number** \_\_\_\_\_

**Total Score** \_\_\_\_\_

\_\_\_\_\_ 1. Laptop (5)

\_\_\_\_\_ 2. Robot (5)

\_\_\_\_\_ 3. Software Match (5)

\_\_\_\_\_ 4. Comments (10)

\_\_\_\_\_ 5. Variables (10)

\_\_\_\_\_ 6. Programming Structure (10)

\_\_\_\_\_ 7. Functions (10)

\_\_\_\_\_ 8. Format (10)

\_\_\_\_\_ 9. Walkthrough (10)

\_\_\_\_\_ 10. Number of Sensors (5)

\_\_\_\_\_ 11. Code for Sensor (10)

\_\_\_\_\_ **Subtotal (90)**

\_\_\_\_\_ Professional Dress: 5 points per student if shirt is fully tucked in as they walk into interview. (10)

\_\_\_\_\_ **Total Score: Copy this number to the top of sheet (100)**

Programming Skills Matches

(1-minute matches)

Team Number \_\_\_\_\_

Highest Score \_\_\_\_\_

**Trial 1**

**Trial 1 Score:**

**Trial 2**

**Trial 2 Score:**

**Trial 3**

**Trial 3 Score:**

Driving Skills Matches

Team Number \_\_\_\_\_

(1-minute matches)

Highest Score \_\_\_\_\_

**Trial 1**

**Trial 1 Score:**

**Trial 2**

**Trial 2 Score:**

**Trial 3**

**Trial 3 Score:**

**Team Number** \_\_\_\_\_

## Mobile Robotics Technology Overall Scorecard

Scoring Category	Max Score (Raw x Weight)	Raw Score	Weight	Total Score
Professional Development Test	25 x 1 = 25		1	
Engineering Notebook	45 x 4 = 180		4	
CAD Drawings	5 x 5 = 25		5	
Design Interview	30 x 6 = 180		6	
Programming Interview	100 x 2 = 200		2	
Highest Programming Skills Score	150 x 1 = 150		1	
Highest Driving Skills Score	150 x 1 = 150		1	
Safety Points	90 x 1 = 90		1	
<b>Total Points</b>	<b>1000</b>	<b>N/A</b>	<b>N/A</b>	

Used for tiebreaking purposes only:

\_\_\_\_\_ Engineering Notebook Score

\_\_\_\_\_ Team's highest Programming Skills Score

\_\_\_\_\_ Team's highest Driving Skills Score



# MOBILE ROBOTICS TECHNOLOGY

## APPENDIX G

# The Robot

## Overview

This section provides rules and requirements for the design and construction of your *Robot*. A VEX Robotics Competition *Robot* is a remotely operated and/or autonomous vehicle designed and built by a registered VEX Robotics Competition *Team* to perform specific tasks.

There are specific rules and limitations that apply to the design and construction of your *Robot*. Please ensure that you are familiar with these *Robot* rules before beginning your *Robot* design. These “inspection rules” are verified prior to the beginning of each event, in a formal *Robot* Inspection.

Inspection Rules are “pass/fail”; there are no Major or *Minor Violations*, only *Violations*. The penalty for all *Violations* is the same, as outlined in <R3d> and <R27>.

Most of these rules are “hard limits,” such as the maximum number of motors permitted. However, some are “at inspector discretion,” such as determining a mechanism’s potential safety risk. At many events, the lead inspector and the *Head Referee* are the same person; if they are not, then the volunteer inspector should confirm any questionable judgment calls with the *Head Referee*. The *Head Referee* has final authority regarding all *Robot* rules, since it is ultimately their decision whether a *Robot* takes the field for a *Match* after inspection has concluded (per <R3d> and <R3e>).

## Inspection Rules

**<R1> One Robot per Team.** Only one (1) *Robot* will be allowed to compete per *Team* at a given event in the VEX Robotics Competition. Though it is expected that *Teams* will make changes to their *Robot* at the competition, a *Team* is limited to only one (1) *Robot* at a given event. A VEX *Robot*, for the purposes of the VEX Robotics Competition, has the following subsystems:

- Subsystem 1: Mobile robotic base including wheels, tracks, legs, or any other mechanism that allows the *Robot* to navigate the majority of the flat playing field surface. For a stationary *Robot*, the robotic base without wheels would be considered Subsystem 1.
- Subsystem 2: Power and control system that includes a legal VEX battery, a legal VEX control system, and associated motors for the mobile robotic base.

- Subsystem 3: Additional mechanisms (and associated motors) that allow manipulation of *Triballs*, Field Elements, or navigation of field obstacles.

Given the above definitions, a minimum *Robot* for use in any VEX Robotics Competition event (including Skills Challenges) must consist of subsystems 1 and 2 above. Thus, if you are swapping out an entire subsystem 1 or 2, you have now created a second *Robot* and have *Violated* this rule.

- Teams* may not compete with one *Robot* while a second is being modified or assembled at a competition.
- Teams* may not have an assembled second *Robot* on-hand at a competition that is used to repair or swap parts with the first *Robot*.
- Teams* may not switch back and forth between multiple *Robots* during a competition. This includes using different *Robots* for *Skills Challenges*, *Qualification Matches* and/or *Elimination Matches*.
- Multiple *Teams* may not use the same *Robot*. Once a *Robot* has competed under a given *Team* number at an event, it is “their” *Robot*; no other *Teams* may compete with it for the duration of the competition season.

The intent of <R1a>, <R1b>, and <R1c> is to ensure an unambiguous level playing field for all *Teams*. *Teams* are welcome (and encouraged) to improve or modify their *Robots* between events, or to collaborate with other *Teams* to develop the best possible game solution.

However, a *Team* who brings and/or competes with two separate *Robots* at the same tournament has diminished the efforts of a *Team* who spent extra design time making sure that their one *Robot* can accomplish all of the game’s tasks. A multi-*Team* organization that shares a single *Robot* has diminished the efforts of a multi-*Team* organization who puts in the time, effort, and resources to undergo separate individual design processes and develop their own *Robots*.

To help determine if a *Robot* is a “separate *Robot*” or not, use the subsystem definitions found in <R1>. Above that, use common sense as referenced in <G3>. If you can place two *Robots* on a table next to each other, and they look like two separate legal/complete *Robots* (i.e., each has the 3 subsystems defined by <R1>), then they are two *Robots*. Trying to decide if changing a screw, a wheel, or a microcontroller constitutes a separate *Robot* is missing the intent and spirit of this rule.

<R2> **Robots must represent the Team’s skill level.** The *Robot* must be designed, built, and programmed by members of the *Team*. *Adults* are expected to mentor and teach design, building, and

Programming Skills to the *Students* on the *Team*, but may not design, build, or program that *Team's Robot*. See rules <G2> and <G4>.

In VRC, we expect *Adults* to teach fundamental *Robot* principles like linkages, drive-trains, and manipulators, then allow the *Students* to determine which designs to implement and build on their *Robot*.

Similarly, *Adults* are encouraged to teach the *Students* how to code various functions involving applicable sensors and mechanisms, then have the *Students* program the *Robot* from what they have learned.

**<R3> Robots must pass inspection.** Every *Robot* will be required to pass a full inspection before being cleared to compete. This inspection will ensure that all *Robot* rules and regulations are met. Initial inspections will take place during team registration/practice time. Noncompliance with any *Robot* design or construction rule will result in removal from *Matches* or *Disqualification* of the *Robot* at an event until the *Robot* is brought back into compliance, as described in the following subclauses.

- a. Significant changes to a *Robot*, such as a partial or full swap of Subsystem 3, must be re-inspected before the *Robot* may compete again.
- b. All possible functional *Robot* configurations must be inspected before being used in competition. This especially pertains to modular or swappable mechanisms (per <R1>) and *Match* starting configurations/sizes (per <R4>).
- c. *Teams* may be requested to submit to random spot inspections by *Head Referees*. Refusal to submit will result in *Disqualification*.
  - i. If a *Robot* is determined to be in *Violation* of a *Robot* rule before a *Match* begins, the *Robot* will be removed from the field. A *Drive Team Member* may remain at the field so that the *Team* does not get assessed a “no-show” (per <T5>).
- d. *Robots* which have not passed inspection (i.e., that may be in *Violation* of one or more *Robot* rules) will not be permitted to play in any *Matches* until they have done so.<T5> will apply to any *Matches* that occur until the *Robot* has passed inspection.
- e. If a *Robot* has passed inspection, but is later confirmed to be in *Violation* of a *Robot* rule during or immediately following a *Match* by a *Head Referee*, they will be *Disqualified* from that *Match*. This is the only *Match* that will be affected; any prior *Matches* that have already been completed will not be revisited. <R3d> will apply until the *Violation* is remedied and the *Team* is re-inspected.
- f. All Inspection Rules are to be enforced within the discretion of the *Head Referee* within a given event.*Robot* legality at one event does not automatically imply legality at future events.*Robots* which rely on “edge-case” interpretations of subjective rules, such as whether a decoration is “non-functional” or not, should expect additional scrutiny during inspection.

**<R4> Robots must fit within an 18" x 18" x 18" volume.**

- a. Compliance with this rule must be checked using the official VEX Robotics On-Field Robot Expansion Sizing Tool: <https://www.vexrobotics.com/276-5942.html>.
- b. Any restraints used to maintain starting size (i.e., zip ties, rubber bands, etc.) must remain attached to the *Robot* for the duration of the *Match*, per <G6>.
- c. For the purposes of this rule, it can be assumed that *Robots* will be inspected and begin each *Match* on a flat standard foam field tile.

The official sizing tool is intentionally manufactured with a slightly oversized tolerance. Therefore, any contact with the sizing tool (i.e., a “paper test”) while being measured should be considered a clear indication that a *Robot* is outside of the permitted size. This tolerance also provides a slight “leeway” for minor protrusions, such as screw heads or zip ties.

Other tools, such as custom sizing boxes or the legacy non-expanding VEX Sizing Tool (276-2086), may be used for informal checks. However, in the event of a conflict or “close call,” a check with the official On-Field Robot Expansion Sizing Tool takes precedence.

Although it is not required by <R4>, events may also choose to check that any possible *Robot* expansion satisfies the requirements of <SG2> during inspection. The intent of this check is to help *Teams* identify any potential *Violation* risks before their *Matches*.

**<R5> Robots must be safe.** The following types of mechanisms and components are NOT allowed:

- a. Those that could potentially damage Field Elements or *Triballs*.
- b. Those that could potentially damage other competing *Robots*.
- c. Those that pose an unnecessary risk of *Entanglement* with other *Robots* or a net.
- d. Those that could pose a potential safety hazard to *Drive Team Members*, event staff, or other humans.

**<R6> Robots are built from the VEX V5 system.** *Robots* may be built ONLY using official VEX V5 components, unless otherwise specifically noted within these rules. *Teams* are responsible for providing documentation proving a part’s legality in the event of a question. Examples of documentation include receipts, part numbers, official VEX websites, or other printed evidence.

- a. Products from the VEXpro, VEX EXP, VEX IQ, VEX GO, VEX 123, or VEX Robotics by HEXBUG\* product lines cannot be used for *Robot* construction, unless specifically allowed by a clause of <R7> or “cross-listed” as part of the VEX V5 Product lines. For example, Flex

Wheels and VersaHubs are VEXpro components that can be found on the VEX “Flex Wheels” page, and are thus legal: <https://www.vexrobotics.com/vrc-flex-wheels.html>.

\* The HEXBUG brand is a registered trademark belonging to Spin Master Corp

b. The following electronics from the VEX Cortex control system are not permitted.

SKU	Description
276-2192	VEXnet Joystick
276-1891	VEXnet Partner Joystick
276-2194	VEX ARM® Cortex-based Microcontroller
276-2245 / 276-3245	VEXnet Key 1.0 / 2.0
276-2177	2-Wire Motor 393
276-2162	3-Wire Servo
276-2210	VEX Flashlight
276-2193	Motor Controller 29

c. The following electronics from the VEX Cortex control system are permitted.

SKU	Description
276-2174 / 276-4859	Limit Switch V1 / V2
276-2159	Bumper Switch
276-2156	Optical Shaft Encoder
276-2216	Potentiometer
276-2155	Ultrasonic Range Finder
276-2176	LED Indicator
276-2333	Yaw Rate Gyroscope
276-2332	Analog Accelerometer V1.0
276-2154	Line Tracker
276-1380	Jumper

d. Components that are unique to the V5 Workcell product line are not permitted.

SKU	Description
276-7151	Robot Arm Metal
276-7152	Robot Brain Mount
276-7153	Input Output Conveyor
276-7720	Disc Feeder
276-7047	V5 Electromagnet

e. This includes the following.  
VEX IQ pins are permitted.

- f. Components obtained from the V5 beta program, including V5 beta firmware, are not legal for competition use.
  - i. All V5 beta hardware can be identified by its lighter gray pre-production color. Robot Brains, Robot Batteries, Controllers, and Vision Sensors from the V5 beta have a “BETA TEST” stamp on them. Smart Motors and Radios do not have this stamp, but can still be identified by color.
- g. Components from the VEXplorer kit that are not found in modern VEX V5 kits are not permitted. These include (but may not be limited to) electronics, wheels, non-standard gears, and plastic connectors.
- h. Official VEX products are ONLY available from VEX Robotics. All official products are listed on [www.vexrobotics.com](http://www.vexrobotics.com).

Using VEX apparel, competition support materials, packaging, or other non-Robot products on a VEX Robotics Competition Robot goes against the spirit of this rule and is not permitted.

<R7> **Certain non-VEX components are allowed.** *Robots* are allowed the following additional “non-VEX” components:

- a. Any material strictly used as a color filter or a color marker for a legal sensor, such as the VEX Light Sensor or the VEX V5 Vision Sensor.
- b. Any non-aerosol-based grease or lubricating compound, when used in extreme moderation on surfaces and locations that do NOT contact the playing field walls, foam field surface, *Triballs*, or other *Robots*. Grease or lubricant applied directly to V5 Smart Motors or Smart Motor cartridges is prohibited.
- c. Anti-static compound, when used in extreme moderation (i.e., such that it does not leave residue on Field Elements, *Triballs*, or other *Robots*).
- d. Hot glue when used to secure cable connections.
- e. An unlimited amount of rope / string, no thicker than 1/4” (6.35mm).

- f. Commercially available items used solely for bundling or wrapping of 2-wire, 3-wire, 4-wire, or V5 Smart Cables, and/or pneumatic tubing are allowed. These items must solely be used for the purposes of cable/tubing protection, organization, or management. This includes but is not limited to electrical tape, cable carrier, cable track, etc. It is up to inspectors to determine whether a component is serving a function beyond protecting and managing cables and tubing.
- g. Non-functional 3D printed license plates, per <R8> and <R9>, are permitted. This includes any supporting structures whose sole purpose is to hold, mount, or display an official license plate.
- h. Rubber bands that are identical in length and thickness to those included in the VEX V5 product line (#32, #64 and 117B).
- i. Pneumatic components with identical SMC manufacturer part numbers to those listed on the VEX website. For more detail regarding legal pneumatic components, see the Legal VEX Pneumatics Summary document:  
<https://link.vex.com/docs/2023-2024/vrc-over-under/LegalPneumatics>.
- j. Zip ties that are identical in length and thickness to those included in the VEX V5 product line (4" or 11" long).

See this [REC Library Article](#) for more information.

<R8> **Decorations are allowed.** *Teams* may add non-functional decorations, provided that they do not affect *Robot* performance in any significant way or affect the outcome of the *Match*. These decorations must be in the spirit of the competition. Inspectors will have final say in what is considered “non-functional.” Unless otherwise specified below, non-functional decorations are governed by all standard *Robot* rules.

To be considered “non-functional,” any guards, decals, or other decorations must be backed by legal materials that provide the same functionality. For example, if a *Robot* has a giant decal that prevents *Triballs* from falling out of the *Robot*, the decal must be backed by VEX material that would also prevent the *Triballs* from falling out. A simple way to check this is to determine if removing the decoration would impact the performance of the *Robot* in any way.

- a. Anodizing and painting of parts is considered a legal nonfunctional decoration.
- b. Small cameras are permitted as non-functional decorations, provided that any transmitting functions or wireless communications are disabled. Unusually large cameras being used as ballast are not permitted.



- c. VEX electronics may not be used as non-functional decorations.
- d. Decorations that visually mimic Field Elements, or could otherwise interfere with an opponent's Vision Sensor, are considered functional and are not permitted. The Inspector and *Head Referee* will make the final decision on whether a given decoration or mechanism violates this rule.
- e. Internal power sources (e.g., for a small blinking light) are permitted, provided that no other rules are violated and this source only provides power to the non-functional decoration (i.e., does not directly or indirectly influence any functional portions of the *Robot*).
- f. Decorations which provide feedback to the *Robot* (e.g., by influencing legal sensors) would be considered "functional," and are not permitted.
- g. Decorations which provide visual feedback to *Drive Team Members* (e.g., decorative lighting) are permitted, provided that they do not violate any other rules and serve no other function (e.g., structural support).

**<R9> Officially registered Team numbers must be displayed on Robot License Plates.** To participate in an official VEX Robotics Competition event, a *Team* must first register on [robotevents.com](http://robotevents.com) and receive a VRC Team number. This *Team* number must be displayed on a minimum of two (2) sides of the *Robot* using *License Plates*. *Teams* may choose to use the official VRC License Plate Kit, or may create their own.

- a. *Robots* must use plates that match their *Alliance* color for each *Match* (i.e., red *Alliance Robots* must have their red plates on for the *Match*). It must be abundantly clear which color *Alliance* the *Robot* belongs to.
  - i. If both colors of *License Plates* are mounted on a *Robot*, then the incorrect color must be covered, taped over, or otherwise obscured. Since *License Plates* are considered non-functional decorations, this is a legal non-functional use of tape.
- b. *License Plates* are considered non-functional decorations (per <R8>), and must fulfill all relevant *Robot* rules (e.g., they must fit within the 18" cube, cannot functionally change the stability or rigidity of the *Robot*, cause *Entanglement*, etc.)
- c. *Team* numbers must be in white font, and clearly legible.
- d. *License Plates* must be at least 2.48 inches (63.2mm) tall and 4.48 inches (114mm) wide, i.e., at least the height/width dimensions of the plates in the VRC License Plate Kit.

The intent of this rule is to make it immediately apparent to *Head Referees* which *Alliance* and which *Team* each *Robot* belongs to, at all times. Being able to "see through" a *Robot* arm to the wrong color *License Plate* on the opposite side of the *Robot* could cause confusion, and would be considered a violation of <R9a>.

It will be at the full discretion of the *Head Referee* and inspector at a given event to determine whether a

given custom *License Plate* satisfies the criteria listed in [<R9>](#).

*Teams* wishing to utilize custom plates should be prepared for the possibility of this judgment, and ensure that they are prepared to replace any custom parts with official VEX *License Plates* if requested. Not bringing official replacement plates to an event will not be an acceptable reason for overlooking a violation of one or more points in [<R9>](#).

If a *Robot* must be removed from the Field based on this rule, [<R3ci>](#) applies and the *Team* should not be issued a “no-show.”



Figure 34: An example of a License Plate made from the VRC License Plate Kit



Figure 35: An example of a legal custom License Plate

**<R10> Let go of Triballs after the Match.** *Robots* must be designed to permit easy removal of *Triballs* from any mechanism without requiring the *Robot* to have power after a *Match*.

**<R11> Robots have one microcontroller.** *Robots* must ONLY use one (1) VEX V5 Robot Brain (276-4810). Any other microcontrollers or processing devices are not allowed, even as non-functional decorations.

This includes microcontrollers that are part of other VEX product lines, such as VEX Cortex, VEX EXP,

VEXpro, VEX RCR, VEX IQ, VEX GO, or VEX Robotics by HEXBUG. This also includes devices that are unrelated to VEX, such as Raspberry Pi or Arduino devices.

**<R12> Motors are limited.** *Robots* may use any combination of VEX V5 Smart Motors (11W) (276-4840) and EXP Smart Motors (5.5W) (276-4842), within the following criteria:

- a. The combined power of all motors (11W & 5.5W) must not exceed 88W.
- b. V5 Smart Motors, and EXP Smart Motors, connected to Smart Ports, are the only motors that may be used with a V5 Robot Brain. The 3-wire ports may not be used to control motors of any kind.

Examples of legal motor combinations:

Example	A	B	C	D	E
Qty of 11W Motors:	8	7	6	5	0
Qty of 5.5W Motors:	0	2	4	6	16

**<R13> Electrical power comes from VEX batteries only.** *Robots* may use one (1) V5 Robot Battery (276-4811) to power the V5 Robot Brain.

- a. No other sources of electrical power are permitted, unless used as part of a non-functional decoration per <R8e>.
- b. There are no legal power expanders for the V5 Robot Battery.
- c. V5 Robot Batteries may only be charged by a V5 Robot Battery Charger (276-4812 or 276-4841).
- d. V5 Wireless Controllers may only be powered by their internal rechargeable battery.
  - 1. *Teams* are permitted to have an external power source (such as a rechargeable battery pack) plugged into their V5 Controller during a *Match*, provided that this power source is connected safely and does not violate any other rules, such as <G10> or <R15>.

2. Some events may choose to provide field power for V5 Wireless Controllers. If this is provided for all *Teams* at the event, then this is a legal power source for the wireless remotes.

**<R14> No modifications to electronic or pneumatic components are allowed.** Motors (including the internal PTC or V5 Smart Motor firmware), microcontrollers (including V5 Robot Brain firmware), cables, sensors, controllers, battery packs, reservoirs, solenoids, pneumatic cylinders, and any other electrical or pneumatics component of the VEX platform may NOT be altered from their original state in ANY way.

- a. External wires on VEX 2-wire or 3-wire electrical components may be repaired by soldering or using twist/crimp connectors, electrical tape, or shrink tubing such that the original functionality and length are not modified in any way.
  1. Wire used in repairs must be identical to VEX wire.
  2. *Teams* make these repairs at their own risk; incorrect wiring may have undesired results.
- b. *Teams* must use the latest official VEXos firmware updates, found at <https://link.vex.com/firmware>. Custom firmware modifications are not permitted.
- c. *Teams* may make the following modifications to the V5 Smart Motor's user-serviceable features. **This list is all-inclusive**; no other modifications are permitted. Where applicable, the components listed below (in the specific applications listed below) are permissible exceptions to <R20>.
  1. Replacing the gear cartridge with other official cartridges.
  2. Removing or replacing the screws from the V5 Smart Motor Cap (276-6780).
  3. Removing or replacing the threaded mounting inserts (276-6781).
  4. Aesthetic/non-functional labeling (e.g., markers, stickers, paint, etc.).
- d. V5 Smart Motors (11W) **must** use an official VEX V5 gear cartridge. For the purposes of this rule, the gear cartridges found within the V5 Smart Motor are considered "part of the motor." Therefore, any physical or functional modifications to official gear cartridges is not permitted. 11w V5 Smart Motors may only use official VEX motor cartridges
- e. For the purposes of this rule, the V5 Smart Motor Cap is not considered "part of the motor." Therefore, <R15> applies.

**<R15> Most modifications to non-electrical components are allowed.** Physical modifications, such as bending or cutting, of legal metal structure or plastic components are permitted.

- a. Internal or external mechanical repairs of VEX Limit and Bumper switches are permitted.
  1. Modifying the metal arm on the Limit Switch is permitted.
  2. Using components from these devices in other applications is prohibited.
- b. Metallurgical modifications that change fundamental material properties, such as heat treating or melting, are not permitted.
- c. Pneumatic tubing may be cut to desired lengths.
- d. Fusing/melting the end of legal nylon rope/string (see <R7e>) to prevent fraying is permitted.
- e. Welding, soldering, brazing, gluing, or attaching parts to each other in any way that is not provided within the VEX platform is not permitted.
- f. Mechanical fasteners may be secured using Loctite or a similar thread-locking product. This may ONLY be used for securing hardware, such as screws and nuts.

<R16> **Robots use VEXnet.** *Robots* must ONLY utilize the VEXnet system for all wireless *Robot* communication.

- a. Electronics from the Cortex, VEX EXP, VEXpro, VEX RCR, VEXplorer, VEX IQ, VEX GO, or VEX Robotics by HEXBUG product line are prohibited unless otherwise noted in <R6c>.
- b. V5 Controllers may only be used in conjunction with a V5 Robot Brain.
- c. *Teams* are permitted to use the Bluetooth® capabilities of the V5 Robot Brain and/or V5 Controller in *Team* pits or outside of *Matches*. However, VEXnet must be used for wireless communication during *Matches*.
- d. *Teams* are permitted to use the Wi-Fi capabilities of the Vision Sensor in *Team* pits or outside of *Matches*. However, the Vision Sensor must have its wireless transmitting functionality disabled during *Matches*.

<R17> **Give the radio some space.** The V5 Radio must be mounted such that no metal surrounds the radio symbol on the V5 Radio.

It is fine to loosely encapsulate the V5 Radio within *Robot* structure. The intent of this rule is to minimize radio connection issues by minimizing obstructions between VEXnet devices. Burying a radio deep within a *Robot* may result in *Robot* communication issues.

<R18> **A limited amount of custom plastic is allowed.** *Robots* may use custom-made parts cut from certain types of non-shattering plastic. It must be possible to have cut all of the plastic parts on the *Robot* from a single 12" x 24" sheet, up to 0.070" thick.

- a. The intent of the area/thickness constraints is to limit the number of custom plastic parts used in *Robot* construction, not to define an absolute volume. For example, using a sheet which is 0.035" thick does not permit two 12" x 24" sheets' worth of parts.
- b. Plastic parts do not have to be literally cut from the same original 12" x 24" sheet. However, all individual parts must be able to "nest" or rearrange into a 12" x 24" area.
  - i. A collection of parts which theoretically have a total surface area of 288 in<sup>2</sup>, but cannot be nested onto a single 12" x 24" sheet, would not be legal. See Figure 36.
- c. Plastic may be mechanically altered by cutting, drilling, bending, etc. It cannot be chemically treated, melted, or cast. Heating polycarbonate to aid in bending is acceptable.
- d. Legal plastic types include polycarbonate (Lexan), acetal monopolymer (Delrin), acetal copolymer (Acetron GP), POM (acetal), ABS, PEEK, PET, HDPE, LDPE, Nylon (all grades), Polypropylene, and FEP.
- e. Shattering plastic, such as PMMA (also called Plexiglass, Acrylic, or Perspex), is prohibited.
- f. The PET Sheet Variety Pack (276-8340), sold by VEX, is considered "plastic" in the context of this rule, and is subject to the same limitations as "off-the-shelf" plastic sheets.
- g. This rule does not apply to 3D printed plastic parts. 3D printed parts are not permitted in the VEX Robotics Competition, except as non-functional decorations (per <R8>) or as custom *License Plates* (per <R9>).

*Note: The phrase "as cut from a single 12" x 24" sheet" is intended to mean that all individual plastic pieces must be able to theoretically "nest" or rearrange into a 12" x 24" area. The plastic pieces do not have to be cut from the same original 12" x 24" sheet. Teams are encouraged to "map" plastic use on a 12"x24" sheet of paper for reference at tournament inspection.*

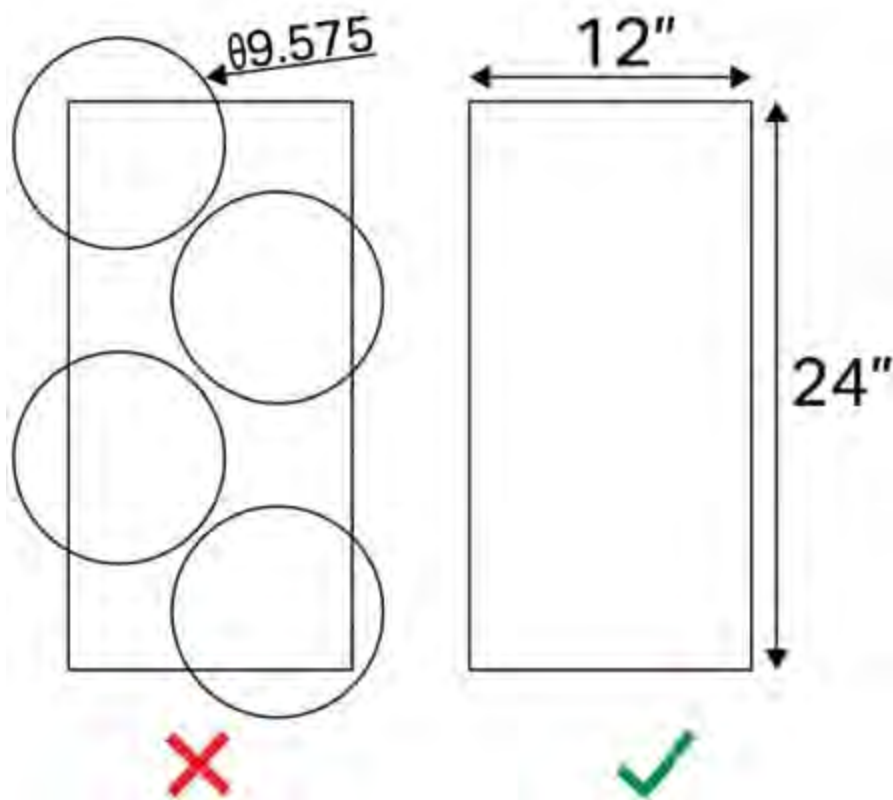

Figure 36: Custom plastic parts must fit within a single 12" x 24" sheet of plastic.

**<R19> A limited amount of tape is allowed.** *Robots* may use a small amount of tape for the following purposes:

- a. To secure any connection between the ends of two (2) VEX cables.
- b. To label wires and motors.
- c. To cover the backs of license plates (i.e., hiding the "wrong color").
- d. To prevent leaks on the threaded portions of pneumatic fittings. This is the only acceptable use of Teflon tape.
- e. In any other application that would be considered a "non-functional decoration" per **<R8>**.

**<R20> Certain non-VEX fasteners are allowed.** *Robots* may use the following commercially available hardware:

- a. #4, #6, #8, M3, M3.5, or M4 screws up to 2.5" (63.5mm) long.
- b. Shoulder screws cannot have a shoulder length over 0.20" or a diameter over 0.176".
- c. Any commercially available nut, washer, standoff, and/or non-threaded spacer up to 2.5" (63.5mm) long which fits these screws.

The intent of the rule is to allow Teams to purchase their own commodity hardware without introducing additional functionality not found in standard VEX equipment. It is up to inspectors to determine whether the

non-VEX hardware has introduced additional functionality or not.

For the purposes of this rule, weight savings is not considered additional functionality.

If a key component of a *Robot's* design relies upon convincing an inspector that a specialized component is “technically a screw,” it is probably outside of the spirit and intent of this rule.

All specific dimensions listed in this rule are intended to be ‘nominal’ references to hardware sizes found within the VEX V5 product line and/or their metric equivalents.

**<R21> New VEX parts are legal.** Additional VEX components released during the competition season on [www.vexrobotics.com](http://www.vexrobotics.com) are considered legal for use unless otherwise noted.

Some “new” components may have certain restrictions placed on them upon their release. These restrictions will be documented in the official Q&A, in a Game Manual Update, or on their respective product web pages.

**<R22> Pneumatics are limited.** A *Robot's* pneumatic subsystem must satisfy the following criteria:

- a. *Teams* may use a maximum of two (2) legal VEX pneumatic air reservoirs on a *Robot*. The Air Tank 200mL (included in the 276-8750 V5 Pneumatics Kit) and the legacy (pre-2023) reservoir are both considered legal reservoirs.
- b. Pneumatic devices may be charged to a maximum of 100 psi.
- c. The compressed air contained inside a pneumatic subsystem can only be used to actuate legal pneumatic devices (e.g., cylinders).

*Note: From a rules perspective, parts found in the V5 Pneumatics Kit (276-8750) and legacy (pre-2023) pneumatic parts may be used interchangeably. This rule will be updated shortly with a link to an updated Legal Pneumatics summary in the VEX Library, which includes additional pneumatics information.*

The intent of <R22a> and <R22b> is to limit *Robots* to the air pressure stored in two reservoir tanks, as well as the normal working air pressure contained in their pneumatic cylinders and tubing on the *Robot Teams*. *Teams* may not use other elements for the purposes of storing or generating air pressure. Using cylinders or additional pneumatic tubing solely for additional storage is in *Violation* of the spirit of this rule.

Using cylinders or additional pneumatic tubing solely for additional storage is in *Violation* of the spirit of this rule. Similarly, using pneumatic cylinders and/or tubing without

any air reservoirs is also in *Violation* of the spirit of this rule.



The intent of <R22c> is to ensure that pneumatics are being used safely. Pressurized systems, such as a *Robot's* pneumatic subsystem, have the potential to be dangerous if used incorrectly. This rule ensures the safety of participants, and prevents potentially unsafe uses in the future.

Another way of thinking of <R22c> is that pneumatics should only be used with pneumatics. *Teams* should not use compressed air as a means of actuating non-pneumatic devices such as screws, nuts, etc. For example, pulling a pin with a pneumatic cylinder is okay, but using air to actuate the pin itself is not.

<R23> **One or two Controllers per Robot.** No more than two (2) VEX V5 Controllers may control a single *Robot*.

- a. No physical or electrical modification of these Controllers are allowed under any circumstances.
  - 1. Attachments which assist the *Drive Team Member* in holding or manipulating buttons/joysticks on the V5 Controller are permitted, provided that they do not involve direct physical or electrical modification of the Controller itself.
- b. No other methods of controlling the *Robot* (light, sound, etc.) are permissible.
  - 1. Using sensor feedback to augment driver control (such as motor encoders or the Vision Sensor) is permitted.

<R24> **Custom V5 Smart Cables are allowed.** *Teams* who create custom cables acknowledge that incorrect wiring may have undesired results.

- a. Official V5 Smart Cable Stock must be used.
- b. Use of non-VEX 4P4C connectors and 4P4C crimping tools is permissible.
- c. V5 Smart Cables may only be used for connecting legal electronic devices to the V5 Robot Brain.

<R25> **Keep the power button accessible.** The on/off button on the V5 Robot Brain must be accessible without moving or lifting the *Robot*. All screens and/or lights must also be easily visible by competition personnel to assist in diagnosing *Robot* problems

<R26> **Use a “Competition Template” for programming.** The *Robot* must be programmed to follow control directions provided by the VEXnet Field Controllers or Smart Field Control system.

During the *Autonomous Period*, *Drive Team Members* will not be allowed to use their V5 Controllers. As such, *Teams* are responsible for programming their *Robot* with custom software if they want to perform in the *Autonomous Period*. *Robots* must be programmed to follow control directions provided by the field

controls (i.e., ignore wireless input during the *Autonomous Period*, disable at the end of the *Driver Controlled Period*, etc.).

*Teams* must use a provided “competition template” or functional equivalent to accomplish this. This will be tested in inspection, where *Robots* will be required to pass a functional “enable/disable” test. For more information on this, *Teams* should consult the help guides produced by the developers of their chosen programming software.

**<R27> There is a difference between accidentally and willfully violating a Robot rule.** Any violation of *Robot* rules, accidental or intentional, will result in a *Team* being unable to play until they pass inspection (per <R3d>).

However, *Teams* who intentionally and/or knowingly circumvent or violate rules to gain an advantage over their fellow competitors are in violation of the spirit and ethos of the competition. Any *Violation* of this sort may be considered a violation of <G1> and/or the REC Foundation Code of Conduct.

# Robot Inspection Checklist

Team Number: \_\_\_\_\_ Division: \_\_\_\_\_

## Size Inspection

<input type="checkbox"/> Robot fits within starting size restrictions (18"x18"x18") with License Plates installed, in all potential starting configurations.	<R4>
<input type="checkbox"/> Robot does not exceed 36" in any horizontal dimension while expanded.	<SG2>

## Overall Inspection

<input type="checkbox"/> Team is only competing with ONE robot. They have no spare or replacement robots. Multiples of subsystem 3 are permitted.	<R1>
<input type="checkbox"/> Robot displays colored Robot License Plates on at least two (2) opposing sides, with only one (1) color visible and the team number displayed legibly in white text.	<R9>
<input type="checkbox"/> Robot does NOT contain any components which will be intentionally detached on the playing field.	<G6>
<input type="checkbox"/> Robot does NOT contain any components that could entangle or damage the playing field or other robots, including sharp edges or corners.	<R5>
<input type="checkbox"/> Robot Brain power button is accessible without moving or lifting the robot.	<R25>
<input type="checkbox"/> Team testifies that the designing, building, and programming of the robot was done only by the students on the team.	<R2>

## VEX Parts Inspection

<input type="checkbox"/> ALL robot components are OFFICIAL VEX V5 components as sold on VEXrobotics.com or materials used as color filters; minimal grease or lubricant; minimal anti-static compound; hot glue for cable connections; unlimited amount of rope/string with a thickness/diameter no larger than 1/4" (6.35mm); rubber bands and zip ties that are identical to those included in the V5 product line; cable protection materials and tape for connections and labeling; and certain non-VEX screws, nuts, and washers.	<R6>, <R7>, <R19>, <R20>, <R21>
<input type="checkbox"/> Robot does not use VEX products not intended for use as a robot component or any VEX packaging.	<R6>
<input type="checkbox"/> NO method of attachment NOT provided by the VEX Design System is used (welding, gluing, etc.).	<R15>
<input type="checkbox"/> All functional non-shattering plastic (0.070" or thinner) on the robot fits within the space of a single sheet of material not larger than 12"x24".	<R18>
<input type="checkbox"/> ALL components on the robot NOT meeting VRC inspection criteria are NON-FUNCTIONAL decorations that do not imitate game or field objects as a distraction for the V5 Vision Sensor.	<R8>
<input type="checkbox"/> Robot has only (1) VEX V5 Robot Brain and no additional microcontrollers.	<R11>
<input type="checkbox"/> Robot utilizes the VEXnet wireless communication system and no other wireless communication during matches.	<R16>
<input type="checkbox"/> Total power of motors is limited to 88W equivalence. Quantity of 11W _____ × 11 = _____ Quantity of 5.5W _____ × 5.5 = _____ Total power = _____ (sum of above)	<R12>
<input type="checkbox"/> Robot uses a maximum of two (2) VEX pneumatic air reservoirs (maximum 100 psi per air reservoir) and the compressed air contained inside a pneumatic sub-system is only being used to actuate legal pneumatic devices.	<R22>
<input type="checkbox"/> Robot uses only one (1) V5 Robot Battery.	<R13>
<input type="checkbox"/> Robot is controlled by no more than two (2) V5 Controllers.	<R23>
<input type="checkbox"/> NO VEX electrical or pneumatic components have been modified from their original state.	<R14>
<input type="checkbox"/> None of the electronics are from the V5 Beta, VEXplorer, VEXpro, VEX-RCR, VEX IQ, VEX Cortex, or VEX Robotics by Hexbug. This includes the EXP Brain, EXP Controller, EXP battery, and VEX 2-wire Motors.	<R6> <R12>
<input type="checkbox"/> If any custom cables are used, they are made only with official V5 Cable Stock.	<R24>
<input type="checkbox"/> Robot Brain has the latest firmware listed on VEX.com/firmware. If an event uses the Smart Field Control System, the robot brain must be named with the team number & letter (with no spaces).	<R14>
<input type="checkbox"/> The Robot correctly responds to enable/disable tests (ignores input from the controller during autonomous, etc.).	<R26>

## Team Verification

Initial

<input type="checkbox"/> Team has fully read and understands the game manual and Q&As, including but not limited to G1-G4, R1, R2, and T1.	
<input type="checkbox"/> Team and coach have fully read and understand the Code of Conduct and Student-Centered Policy.	

Final Inspection **Pass**

*(Circle when passed)*

Inspector Signature: \_\_\_\_\_

Student team member accepts these Inspection results and certifies that this robot was designed, built, and programmed by qualified students on this team with little to no assistance from the adult mentor(s):

Team Member Signature: \_\_\_\_\_ Coach Signature: \_\_\_\_\_